



# *Irrigation Hydrants & Spares*



PRODUCT	DESCRIPTION	CODE
---------	-------------	------

### THREADED PIPE RISERS

#### GAL STEEL RISERS THREADED BOTH ENDS WITH PLASTIC THREAD PROTECTORS



#### 80mm

80mm x 300mm Long  
80mm x 450mm Long  
80mm x 600mm Long  
80mm x 750mm Long

**GSR80300**  
**GSR80450**  
**GSR80600**  
**GSR80750**

#### 100mm

100mm x 300mm Long  
100mm x 450mm Long  
100mm x 600mm Long  
100mm x 750mm Long

**GSR100300**  
**GSR100450**  
**GSR100600**  
**GSR100750**

#### 125mm

125mm x 300mm Long  
125mm x 450mm Long  
125mm x 600mm Long  
125mm x 750mm Long

**GSR125300**  
**GSR125450**  
**GSR125600**  
**GSR125750**

#### PVC (Schedule 80 Grey) RISERS THREADED BOTH ENDS WITH PLASTIC THREAD PROTECTORS



#### 80mm

80mm x 240mm Long  
80mm x 300mm Long  
80mm x 450mm Long  
80mm x 600mm Long  
80mm x 750mm Long

**PVCR80240**  
**PVCR80300**  
**PVCR80450**  
**PVCR80600**  
**PVCR80750**

#### 100mm

100mm x 300mm Long  
100mm x 450mm Long  
100mm x 600mm Long  
100mm x 750mm Long

**PVCR100300**  
**PVCR100450**  
**PVCR100600**  
**PVCR100750**

### FLOOD GATES

#### ROUGHNECK KEYHOLE GATE FOR ALUMINIUM & P.V.C. - FITS 6" & 5" PIPE (4" See Note Below)



Roughneck Keyhole Gate Fits 6" & 5" Pipe  
Roughneck Keyhole Screw Only  
(When installed in 4" Aluminium a small amount of leaking may occur unless pipe is slightly flatten. PVC will Leak.)

**KH-200**  
**KH-100S**

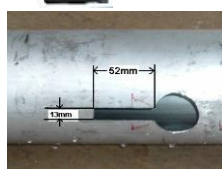

Drill the pipe with 38mm Solid Hole Saw. Mark out the side slot (52mm x 13mm). Cut the side slot with a Jigsaw. End up with a Keyhole. Fit the back of Gate through the hole but don't let go of it. Hold from behind with your finger. Slot the cover over the outside. Insert the Orange Screw. Loosen the Orange Screw and slide the gate along to the position required, then tighten the Orange Screw to hold into position. It can be closed, partly open or fully open and can be slid along during operation by tapping with a blunt object.

The output from this Keyhole is the same as the Rite-Flo 1½" Gate.

#### "RITE FLO" FLOOD GATE SPARE PARTS (Only available while stock I ast!)

1½" Valve Seal Gasket (Small)	<b>RF10</b>	<b>\$0.80</b>	<b>\$0.88</b>	<b>A</b>
1½" Pipe Seal Gasket (Large)	<b>RF11</b>	<b>\$0.80</b>	<b>\$0.88</b>	<b>A</b>
2½" Valve Seal Gasket (Small)	<b>RF12</b>	<b>\$1.20</b>	<b>\$1.32</b>	<b>A</b>

PRODUCT	DESCRIPTION	CODE
---------	-------------	------

**"RJ" PRODUCTS**



**"RJ" ALUMINIUM VALVE RISER SCREWED ( SHUR-RANE TYPE)**

100mm (4") "RJ" Valve Riser Screwed  
125mm (5") "RJ" Valve Riser Screwed

**VR4**  
**VR5**



**"RJ" ALUMINIUM VALVE RISER FLANGED (TABLE "D")**

100mm (4") "RJ" Valve Riser Flanged (Table "D")  
125mm (5") "RJ" Valve Riser Flanged (Table "D")

**VRF4**  
**VRF5**



**"RJ" ALUMINIUM VALVE RISER SEALING CAP (With Vee Gasket)**

100mm (4") "RJ" Valve Riser Sealing Cap (E5732 Gasket)  
125mm (5") "RJ" Valve Riser Sealing Cap (E4477 Gasket)

**SC4**  
**SC5**



**"RJ" ALUMINIUM VALVE ELBOW ( SHUR-RANE TYPE)**

**When using for Irrigators the side lugs are the only recommended attachment.**

100mm (4") "RJ" Valve Riser Elbow  
125mm (5") "RJ" Valve Riser Elbow

**VE4**  
**VE5**

**"RJ" ALUMINIUM VALVE ELBOW EXTENSION**



125mm (5") "RJ" Valve Riser Elbow Extension  
**Valve Elbow Extension is complete with swivel bracket, extended pusher block, Vee Gasket & Split Pin.**

**EX5**

**"RJ" ALUMINIUM CLAMP ON FLANGE TABLE "D" COMPLETE**

**(Includes clamps, o-rings, bolts & nuts)**



80mm (3") "RJ" Clamp On Flange (J0361 O' Ring)  
100mm (4") "RJ" Clamp On Flange (J0160 O' Ring)  
125mm (5") "RJ" Clamp On Flange (J0362 O' Ring)  
150mm (6") "RJ" Clamp On Flange (J1164 O' Ring)

**COF3**  
**COF4**  
**COF5**  
**COF6**

**"RJ" ALUMINIUM WELD ON FLANGE TABLE "D"**



80mm (3") "RJ" Weld On Flange  
100mm (4") "RJ" Weld On Flange  
125mm (5") "RJ" Weld On Flange  
150mm (6") "RJ" Weld On Flange

**WF3**  
**WF4**  
**WF5**  
**WF6**

**TAPPING BAND FOR 100mm (4") ALUMINUM PIPE**



Tapping Band with 1 X 40mm (1½") Male BSP Take-Off for 100mm (4") Aluminium Pipe (Includes 1 X Take-Off Seal & 4 x Bolts & Nuts)

**ATB440-1**



Tapping Band with 2 X 40mm (1½") Male BSP Take-Offs for 100mm (4") Aluminium Pipe (Includes 2 X Take-Off Seals & 4 X Bolts & Nuts)

**ATB440-2**



PRODUCT	DESCRIPTION	CODE
---------	-------------	------

**"RJ" PRODUCT SPARES**

**"RJ" VALVE RISER SPARES**

100mm (4") "RJ" Valve disc (Rubber coated sealing disc) <b>Includes 2 x VR14 Washers</b>	<b>VR10</b>
125mm (5") "RJ" Valve disc (Rubber coated sealing disc) <b>Includes 2 x VR14 Washers</b>	<b>VR11</b>
Valve Riser Stainless Steel Spindle	<b>VR12</b>
Valve Riser Top Washer (Large) (Fits above spring at top of spindle)	<b>VR13</b>
Valve Riser Bottom Washer (Small) <b>(One above &amp; one beneath the Valve Riser Disc)</b>	<b>VR14</b>
Valve Riser Bottom Nut (Fits at bottom of S/S Spindle)	<b>VR15</b>
Valve Riser S/S Split Pin (Retains Washer at top of Spindle)	<b>VR16</b>
Valve Riser Stainless Steel Spring	<b>VR17</b>

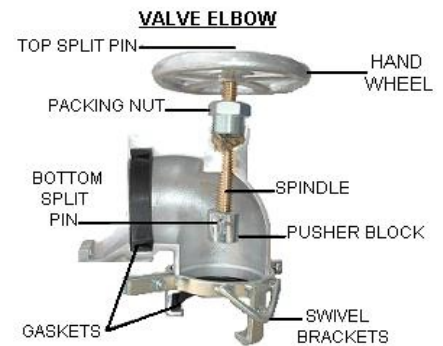
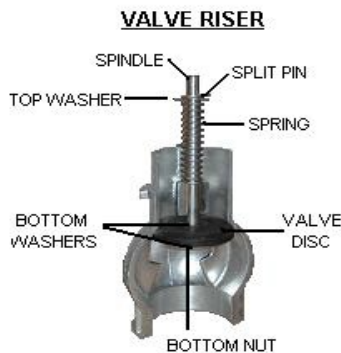

**"RJ" VALVE ELBOW SPARES**

100mm (4") Valve Elbow Gasket (Vee Rubber)	<b>J159</b>
125mm (5") Valve Elbow Gasket (Vee Rubber)	<b>J282</b>
100mm (4") Valve Elbow Swivel Bracket (Complete with Bolts & Nuts)	<b>VE18</b>
125mm (5") Valve Elbow Swivel Bracket (Complete with Bolts & Nuts)	<b>VE19</b>
Swivel Bracket Bolt & Nut	<b>VE20</b>
Top Split Pin ( Attaches hand wheel to brass spindle)	<b>VE21</b>
Hand Wheel	<b>VE22</b>
Brass Spindle	<b>VE23</b>
Stainless Steel Spindle (Optional)	<b>VE23SS</b>
Packing Nut (Gland nut on top of Elbow body)	<b>VE24</b>
Standard Pusher Block (Attaches to bottom of brass spindle)	<b>VE25</b>
Bottom Split Pin (Attaches pusher block to brass spindle)	<b>VE26</b>

**"RJ" VALVE ELBOW EXTENSION SPARES**

Extended Pusher Block	<b>VX27</b>
100mm (4") Valve Elbow Gasket (Vee Rubber)	<b>J159</b>
125mm (5") Valve Elbow Gasket (Vee Rubber)	<b>J282</b>

**"RJ" VALVE RISER SEALING CAP SPARES**

100mm (4") Valve Riser Sealing Cap Vee Gasket	<b>E5732</b>
125mm (5") Valve Riser Sealing Cap Vee Gasket	<b>E4477</b>

**"RJ" CLAMP ON FLANGE SPARES**

80mm (3") Half Clamp	<b>HC3</b>
100mm (4") Half Clamp	<b>HC4</b>
125mm (5") Half Clamp	<b>HC5</b>
150mm (6") Half Clamp	<b>HC6</b>
80mm (3") O' Ring	<b>J0361</b>
100mm (4") O' Ring	<b>J0160</b>
125mm (5") O' Ring	<b>J0362</b>
150mm (6") O' Ring	<b>J1164</b>
Bolt & Nut	<b>CFBN</b>



PRODUCT	DESCRIPTION	CODE
---------	-------------	------

**QISCROSS HYDRANT & SPARES**

**QISCROSS SCREWED HYDRANT (SOUTHERN CROSS TYPE)**



- 80mm (3") QISCROSS Screwed Hydrant
- 100mm (4") QISCROSS Screwed Hydrant
- 125mm (5") QISCROSS Screwed Hydrant

- QH3
- QH4
- QH5

**These Screwed Hydrants are interchangeable with the Southern Cross style hydrants and feature a stainless steel spindle, top cap and sealing plate.**

**QISCROSS HYDRANT OUTLET (SOUTHERN CROSS TYPE)**



- 80mm (3") QISCROSS Hydrant Outlet
- 100mm (4") QISCROSS Hydrant Outlet
- 125mm (5") QISCROSS Hydrant Outlet

- QO3
- QO4
- QO5

**These Hydrant Outlets are interchangeable with the Southern Cross style outlets and comes standard with stainless steel handle and cast stainless drive dog**

**SCREWED HYDRANT**

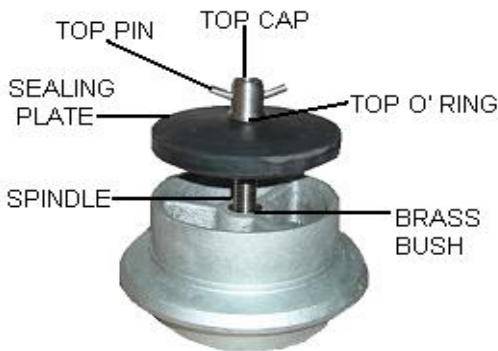

**HYDRANT OUTLET**

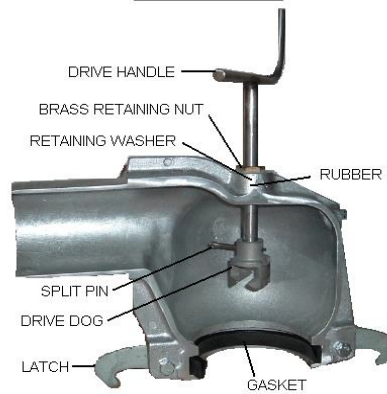

**QISCROSS SCREWED HYDRANT SPARES**

- 80mm (3") Sealing Plate (Rubber coated stainless steel)
- 100mm (4") Sealing Plate (Rubber coated stainless steel)
- 125mm (5") Sealing Plate (Rubber coated stainless steel)
- Spindle Complete (Stainless Steel)(Includes QP4,QP5,QP6)
- Top Cap (Stainless Steel)
- Top Pin (Stainless Steel)
- Top O' Ring
- Brass Bush (Press Fit)

- QP0
- QP1
- QP2
- QP3
- QP4
- QP5
- QP6
- QP14

**QISCROSS HYDRANT OUTLET SPARES**

- Stainless Steel Drive Handle
- Brass Retaining Nut
- Stainless Steel Retaining Washer
- Handle Vee Seal (Rubber)
- Bottom Drive Dog (Cast Stainless Steel)
- Stainless Steel Drive Dog Split Pin
- Steel Side Latch
- 80mm (3") Outlet Gasket (use 100mm (4") QISCROSS Vee Rubber)
- 100mm (4") Outlet Gasket (use 125mm (5") QISCROSS Vee Rubber)
- 125mm (5") Outlet Gasket (use 150mm (6") QISCROSS Vee Rubber)

- QP7
- QP8
- QP9
- QP10
- QP11
- QP12
- QP13
- E4672
- E4665
- E5753

**QISCROSS FEMALE ADAPTOR (ALUMINIUM) COMPLETE WITH VEE RUBBER**



- 125mm (5") Female Adaptor Aluminium Complete with J282 Vee Rubber. For Welding to QO5

- QO5FA



PRODUCT	DESCRIPTION	CODE
---------	-------------	------

**READ HYDRANTS AND SPARES - 80mm (3") TO 150mm (6")**

**READ SCREWED HYDRANTS**



- 80mm (3") Read Hydrant Valve BSP FI
- 100mm (4") Read Hydrant Valve BSP FI
- 125mm (5") Read Hydrant Valve BSP FI
- 150mm (6") Read Hydrant Valve BSP FI

- RHV80
- RHV100
- RHV125
- RHV150

**READ HYDRANT TAKE-OFF ELBOW**



- 80mm (3") Read Hydrant Take-Off Elbow BSP FI
- 100mm (4") Read Hydrant Take-Off Elbow BSP FI
- 125mm (5") Read Hydrant Take-Off Elbow BSP FI
- 150mm (6") Read Hydrant Take-Off Elbow BSP FI

- RHTO80
- RHTO100
- RHTO125
- RHTO150

**READ EXTENDED HYDRANT TAKE-OFF ELBOW**



- 80mm (3") Read Extended Take-off Elbow BSP FI
- 100mm (4") Read Extended Take-off Elbow BSP FI
- 150mm (5") Read Extended Take-off Elbow BSP FI
- 150mm (6") Read Extended Take-off Elbow BSP FI

- RETO80
- RETO100
- RETO125
- RETO150

**READ HYDRANT SPARES**

- Cap Bare for 4"
- Cap Bare for 5"
- Cap Bare for 6"
- Spindle Nut for 3"
- Spindle Nut for 4" and 5"
- Spindle Nut for 6"
- Locknut for 3"
- Locknut for 4", 5" and 6"
- Spindle for 3" and 4"
- Spindle for 5"
- Spindle for 6"
- 3/4 Nylon Washer For 3", 4", 5" and 6"
- 3/4 Gal Cap Washer For 3", 4", 5" and 6"
- 3/4 Stainless Steel Pin For 3", 4", 5" and 6"
- Cap Washer Seal for 3"
- Cap Washer Seal for 4"
- Cap Washer Seal for 5"
- Cap Washer Seal for 6"

- RHV100/2
- RHV125/2
- RHV150/2
- RHV80/3
- RHV100/3
- RHV150/3
- RHV80/4
- RHV150/4
- RHV80/5
- RHV125/5
- RHV150/5
- RHV150/6
- VR13
- VR16
- RHV80/9
- RHV100/9
- RHV125/9
- RHV150/9

**READ TAKE-OFF ELBOW SPARES**

- Gland Seal For 3", 4", 5" and 6"
- Winding Handle For 3", 4", 5" and 6"
- Bottom Drive Dog For 3", 4", 5" and 6"
- Vee Seal 3" (4" Diam)
- Vee Seal 4" (5" Diam)
- Vee Seal 5" (6" Diam)
- Vee Seal 6" (7" Diam)
- Elbow Gland Seal Nut 3", 4" and 5"
- Clamp (Latches) for 3"
- Clamp (Latches) for 4", 5" & 6"

- RHTO150/4
- RHTO150/6
- RHTO150/9
- RHTO80/11
- RHTO100/11
- RHTO125/11
- RHTO150/11
- RHTO100/2
- RHTO80/12
- RHTO150/12

**READ CAST ALUMINIUM HYDRANT**



**READ CAST ALUMINIUM OUTLET ELBOW**

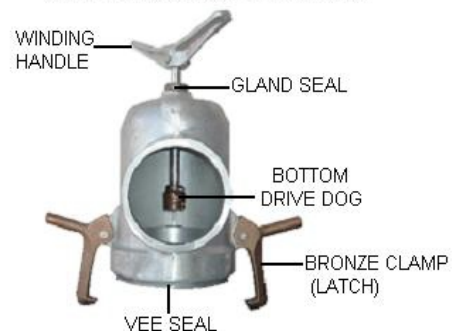



PRODUCT	DE	CODE
---------	----	------

**IEC HYDRANTS & SPARES**

**IEC OUTLET BEND & PARTS**

IEC to Female Outlet Elbow Complete 100mm (4")				<b>IECVE4</b>
IECVE4 Extended Pusher Block				<b>IECX27</b>
Vee Rubber for Elbow Outlet				<b>J159</b>
IEC Handle				<b>IEC62</b>
IEC Brass Spindle				<b>IEC60</b>
IEC Brass Pusher Nut				<b>IEC57</b>
IEC Brass Locking Ring 100mm (4")				<b>IEC52</b>
IEC Dust Cover & Seal only 100mm (4")				<b>IEC55</b>
IEC Dust Cover with Seal & Locking Ring 100mm (4")				<b>IEC99</b>
	<b>O.D.</b>	<b>I.D.</b>	<b>HT.</b>	
IEC Bend Rubber 80mm (3")	110	89	12	<b>IEC42</b>
IEC Bend Rubber 100mm (4")	127	107	15	<b>IEC43</b>
IEC Bend Rubber 154mm (5")	154	137	14	<b>IEC44</b>

**IEC to FEMALE ELBOW**



**IECVE4**

**IEC VALVE REPLACEMENT ADAPTOR**  
Fits both Trailco and Hardie style.



**IECADAP**

**IEC OLD STYLE ELBOW PARTS**

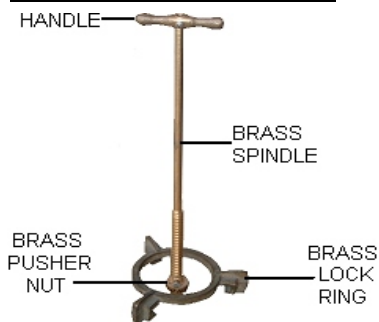

**IEC HYDRANT VALVE PARTS**

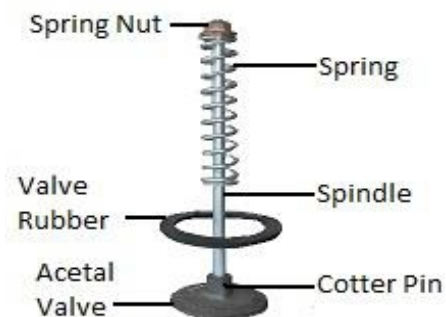

**IEC VALVE PARTS**

IEC Valve Replacement Adaptor to 100mm (4") FI BSPT With IEC13 Rubber Seal (No Bolts Supplied)				<b>SCRIPTION</b>	<b>IECADAP</b>
IEC Spring Nut					<b>IEC22</b>
IEC 225mm (9") Spindle					<b>IEC17</b>
IEC 300mm (12") Spindle					<b>IEC18</b>
IEC 125mm (5") Spring					<b>IEC20</b>
IEC 150mm (6") Spring					<b>IEC21</b>
IEC Cotter Pin					<b>IEC24</b>
IEC Acetal Valve 100mm (4") (Approx 103mm Dia.)					<b>IEC15</b>
IEC Acetal Valve 125mm (5") (Approx 123mm Dia.)					<b>IEC16</b>
	<b>O.D.</b>	<b>I.D.</b>	<b>HT.</b>		
IEC Valve Rubber 100mm (4") x 80mm (3")	124	70	5	<b>IEC09</b>	
IEC Valve Rubber 100mm (4") x 100mm (4")	123	94	5	<b>IEC10</b>	
IEC Valve Rubber 150mm (6") x 80mm (3")	145	73	5	<b>IEC11</b>	
IEC Valve Rubber 150mm (6") x 100mm (4")	144	101	5	<b>IEC12</b>	
IEC Valve Rubber 150mm (6") x 125mm (5")	142	111	5	<b>IEC13</b>	



PRODUCT	DESCRIPTION	CODE
---------	-------------	------

**IEC MISCELLANEOUS PARTS (While Stocks Last)**

IEC Bend Complete 125mm (5") x 80mm (3")	<b>IEC35</b>
IEC Bare Bend 125mm (5") x 100mm (4") (St / St)	<b>IEC40</b>
IEC Spider 80mm (3")	<b>IEC45</b>
IEC Spider 125mm (5")	<b>IEC47</b>
IEC Base Ring for Bend 125mm (5")	<b>IEC50</b>
IEC Lock Ring 80mm (3")	<b>IEC51</b>
IEC Dust Cover 80mm (3") (use IEC42 Bend Rubber)	<b>IEC54</b>
IEC Valve Spindle 450mm (18")	<b>IEC19</b>
IEC 100mm (4") X 100mm (4") Flange (3 Bolt Hole) Base Adaptor 80mm (3") Long Fabricated Gal Steel (To Change 9" IEC Riser into a 12" IEC Riser.) add 1 x IEC 18	<b>IEC81</b>
IEC 100mm (4") X 100mm (4") Base Adaptor 6" Long Fabricated Gal Steel (To Change 12" IEC Riser into a 18" IEC Riser.) add 1 x IEC 19	<b>IEC82</b>

**REPLACEMENT PARTS FOR McCAREY**

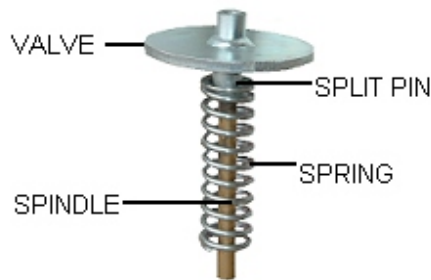

**REPLACEMENT PARTS FOR McCAREY**

	O.D.	I.D.	HT.	
McCarey New Rubber 100mm (4")	234	100	6	<b>MR100</b>
McCarey Split Pin				<b>VE21</b>
McCarey Brass Spindle				<b>MBS</b>
McCarey Spring				<b>MS</b>
McCarey Bend Rubber 80mm (3")	102	77	10	<b>MHBR80</b>
McCarey Bend Rubber 100mm (4")	127	101	12	<b>MHBR100</b>
McCarey Bend Rubber 125mm (5")	149	124	9	<b>MHBR125</b>

**TRAILCO (LPL) HYDRANTS & BENDS**

**TRAILCO (LPL) HYDRANTS**



80mm (3") Trailco Hydrant Valve	<b>81013</b>
100mm (4") Trailco Hydrant Valve	<b>81014</b>
125mm (5") Trailco Hydrant Valve	<b>81015</b>

**TRAILCO (LPL) Hydrant Bends**



80mm (3") Trailco Hydrant Bend	<b>81003</b>
100mm (4") Trailco Hydrant Bend (Hybrid)	<b>81004H</b>
125mm (5") Trailco Hydrant Bend	<b>81005</b>



PRODUCT	DESCRIPTION	CODE
---------	-------------	------

**DIAMOND Y COMPATIBLE PRODUCTS**

**HYDRANT BEND**



- 80mm (3") Hydrant Bend
- 100mm (4") Hydrant Bend (Hybrid)
- 125mm (5") Hydrant Bend

- C400800
- C400100H
- C400125

**HYDRANT BEND SPARES**

- Guide Bush Top O' Ring Number 0.15
- Guide Bush Outside O' Ring Number 0.19
- Guide Bush
- Latch Pin
- Latch
- 80mm (3") Vee Rubbers
- 100mm (4") Vee Rubbers
- 125mm (5") Vee Rubbers
- Handle
- Engagement Pin
- 100mm (4") Hydrant Bend Spindle & Pin
- Handle Pin

- C436
- C437
- C438
- C439
- C440
- C44180
- C441100
- C441125
- C442
- C443
- C444100
- C447

**HYDRANT BEND**

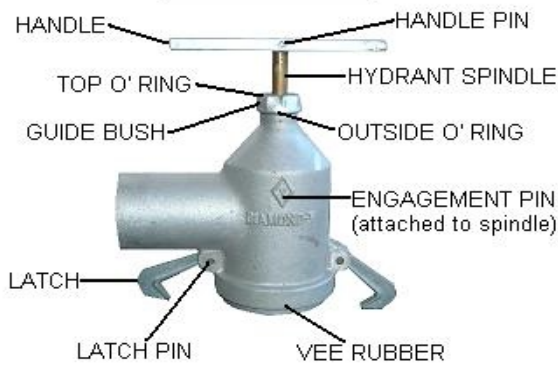

**OUTLET VALVE**

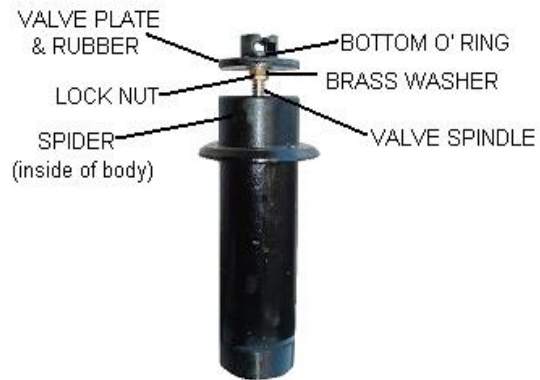

**OUTLET VALVE**



- 80mm (3") Outlet Valve (Top Cast Iron, Riser Gal Steel) Hybrid
- 100mm (4") Outlet Valve (Top Cast Iron Riser Gal Steel) Hybrid
- 125mm (5") Outlet Valve (Top Cast Iron, Riser Gal Steel) Hybrid

- C41080
- C410100
- C410125

**OUTLET VALVE SPARES**

- 80mm (3") Valve Plate (Acetal) & Rubber Complete
- 80mm (3") Valve Plate Rubber Only
- 100mm (4") Valve Plate (Acetal) & Rubber Complete
- 100mm (4") Valve Rubber Only
- 125mm (5") Valve Plate (Acetal) & Rubber Complete
- 125mm (5") Valve Rubber Only

- C43280
- C43280/1
- C432100
- C432100/1
- C432125
- C432125/1

- 80mm (3") Valve Spindle & Head Only  
(No plate/washer/o'ring/locknut)
- 100mm (4") Valve Spindle & Head Only  
(No plate/washer/o'ring/locknut)
- 125mm (5") Valve Spindle & Head Only  
(No plate/washer/o'ring/locknut)

- C43480
- C434100
- C434125

- 3/4" Brass Washer
- Bottom O' Ring Number 0.17
- Lock Nut (2 needed)

- C446
- C448
- C449

- Diamond Y Adaptor Dog

- 81029

PRODUCT	DESCRIPTION	CODE
---------	-------------	------

**RJ SOLID SET COUPLINGS & SPARES**



**RJ SOLID SET COUPLINGS COMPLETE**



40mm (1½") RJ Solid Set Coupling Complete  
50mm (2") RJ Solid Set Couplings Complete

**RJC40**  
**RJC50**

**RJ SOLID SET SPARES**



40mm (1½") RJ Solid Set Coupling Bare  
50mm (2") RJ Solid Set Couplings Bare

**RJC40B**  
**RJC50B**



40mm (1½") RJ Solid Set Lockring Bare  
50mm (2") RJ Solid Set Lockring Bare **N/A Use RJC50L/L**

**RJC40LB**



50mm (2") Lockring and Latch with Bolt & Nut  
**For 50mm (2") RJ Solidset Only**

**RJC50L/L**



40mm (1½") RJ Solid Set Coupling Vee Rubber  
50mm (2") RJ Solid Set Coupling Vee Rubber Medium Drain  
50mm (2") RJ Solid Set Coupling Vee Rubber Non-Drain

**RJ150**  
**FL2M**  
**FL2ND**



RJ Solid Set Latch Only Twisted  
**(This new latch does not require a Spacer)**

**RJLT**

RJ Solid Set Bolt & Nut

**RJBN**

**ALUMINIUM PIPE LINE STRAINER (Stainless Steel) 50mm (2") - 125mm (5")**



50mm (2") Aluminium Line Strainer x 225mm (9")  
80mm (3") Aluminium Line Strainer x 225mm (9")  
100mm (4") Aluminium Line Strainer x 300mm (12")  
125mm (5") Aluminium Line Strainer x 450mm (18")

**ALS2X9**  
**ALS3X9**  
**ALS4X12**  
**ALS5X18**

**50mm (2"), 80mm (3") and 100mm (4") comes with a Stainless steel rim.**  
**125mm (5") comes with a Mild Steel Rim Only.**



PRODUCT	DESCRIPTION	CODE
---------	-------------	------

**CUSTOM ALUMINIUM IRRIGATION COUPLINGS**

**COMPATIBLE WITH POPE FLEXALITE, SOUTHERNCROSS NT, IBC FASTLOCK, FIELDLOCK, CHERAS AND AIM**

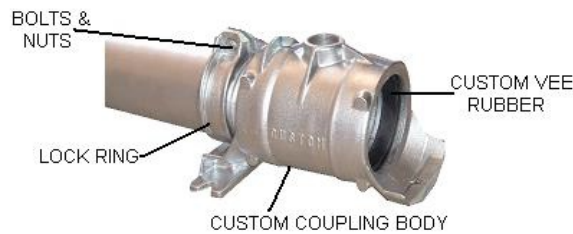

**PLEASE NOTE:**

**RUBBERS ARE NOT INTERCHANGABLE IN SOME CASES. PLEASE REFER TO SEAL SELECTION GUIDE ON PAGES 1 & 2 FOR CORRECT RUBBERS FOR ALL OTHER BRANDS**

**CUSTOM COUPLING COMPLETE** (Body, Lockrings, Bolts & Nuts and Rubbers)

**100 or More Mixed Couplings**

**Medium Drain**

50mm (2") Coupling Complete with <b>Medium Drain</b> Rubbers	<b>CM2M</b>
80mm (3") Coupling Complete with <b>Medium Drain</b> Rubbers	<b>CM3M</b>
100mm (4") Coupling Complete with <b>Medium Drain</b> Rubbers	<b>CM4M</b>

**Non Drain**

50mm (2") Coupling Complete with <b>Non Drain</b> Rubbers	<b>CM2N</b>
80mm (3") Coupling Complete with <b>Non Drain</b> Rubbers	<b>CM3N</b>
100mm (4") Coupling Complete with <b>Non Drain</b> Rubbers	<b>CM4N</b>
125mm (5") Coupling Complete with <b>Non Drain</b> Rubbers	<b>CM5N</b>
125mm (5") Coupling Complete Double Side Tapped	<b>CM5T</b>
40mm (1½") BSP with <b>Non Drain</b> Rubbers	<b>CM5T</b>



**CUSTOM COUPLING SPARES AND CAST ALUMINIUM STOP ENDS**



50mm (2") Custom Coupling Body Bare	<b>CMB2</b>
80mm (3") Custom Coupling Body Bare	<b>CMB3</b>
100mm (4") Custom Coupling Body Bare	<b>CMB4</b>
125mm (5") Custom Coupling Body Bare	<b>CMB5</b>
125mm (5") Custom Coupling Body Bare Double Side Tapped 40mm (1½") BSP	<b>CMB5T</b>



50mm (2") Custom Lock Ring With Bolts & Nuts	<b>CML2</b>
80mm (3") Custom Lock Ring With Bolts & Nuts	<b>CML3</b>
100mm (4") Custom Lock Ring With Bolts & Nuts	<b>CML4</b>
125mm (5") Custom Lock Ring With Bolts & Nuts	<b>CML5</b>
Bolt & Nut (Suit 50mm (2"), 80mm (3"), 100mm (4") Custom Lockring)	<b>CBN4</b>
Bolt & Nut (Suit 125mm (5") Custom Lockring)	<b>CBN5</b>



Steel Top Latch (Suits 2", 3" & 4" Custom Couplings and later Southern Cross couplings) TL	<b>S</b>
---	----------



Steel Top Latch for old Southern Cross coupling (Also for 5" Custom Couplings)	<b>STLSX</b>
---	--------------



50mm (2") Custom Vee Rubber Medium Drain	<b>FL2M</b>
80mm (3") Custom Vee Rubber Medium Drain	<b>FL3M</b>
100mm (4") Custom Vee Rubber Medium Drain	<b>E4672</b>



50mm (2") Custom Vee Rubber Non Drain	<b>FL2ND</b>
80mm (3") Custom Vee Rubber Non Drain	<b>FL3ND</b>
100mm (4") Custom Vee Rubber Non Drain	<b>CM4ND</b>
125mm (5") Custom Vee Rubber Non Drain	<b>CM5ND</b>



50mm (2") Custom Cast Aluminium Stop End	<b>CST2</b>
80mm (3") Custom Cast Aluminium Stop End	<b>CST3</b>
100mm (4") Custom Cast Aluminium Stop End	<b>CST4</b>

PRODUCT	DESCRIPTION	CODE
---------	-------------	------

**QISJAX IRRIGATION COUPLINGS & SPARES (Formerly AJAX)**

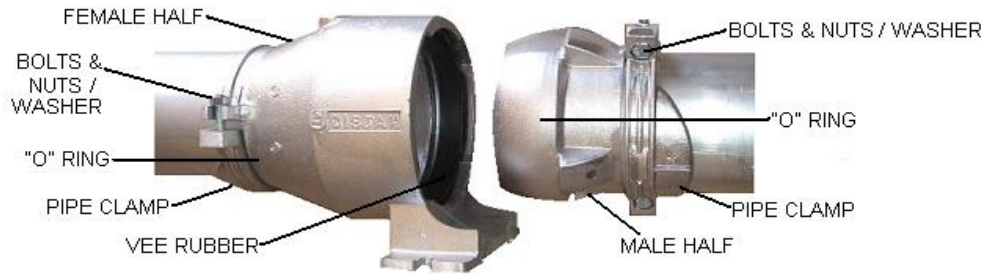

**QISJAX COUPLING COMPLETE**

	50mm (2") QISJAX Coupling Complete	<b>AC-2</b>
	80mm (3") QISJAX Coupling Complete	<b>AC-3</b>
	100mm (4") QISJAX Coupling Complete	<b>AC-4</b>
	125mm (5") QISJAX Coupling Complete	<b>AC-5</b>

**QISJAX FEMALE HALF COMPLETE**

	50mm (2") QISJAX Female Half Complete	<b>ACF-2</b>
	80mm (3") QISJAX Female Half Complete	<b>ACF-3</b>
	100mm (4") QISJAX Female Half Complete	<b>ACF-4</b>
	125mm (5") QISJAX Female Half Complete	<b>ACF-5</b>

**QISJAX MALE HALF COMPLETE**

	50mm (2") QISJAX Male Half Complete	<b>ACM-2</b>
	80mm (3") QISJAX Male Half Complete	<b>ACM-3</b>
	100mm (4") QISJAX Male Half Complete	<b>ACM-4</b>
	125mm (5") QISJAX Male Half Complete	<b>ACM-5</b>

**QISJAX COUPLING SPARES**

50mm (2") QISJAX Female Half Bare	<b>AC2-1</b>
80mm (3") QISJAX Female Half Bare	<b>AC3-1</b>
100mm (4") QISJAX Female Half Bare	<b>AC4-1</b>
125mm (5") QISJAX Female Half Bare	<b>AC5-1</b>
50mm (2") QISJAX Male Half Bare	<b>AC2-2</b>
80mm (3") QISJAX Male Half Bare	<b>AC3-2</b>
100mm (4") QISJAX Male Half Bare	<b>AC4-2</b>
125mm (5") QISJAX Male Half Bare	<b>AC5-2</b>
50mm (2") QISJAX Pipe Clamp	<b>AC2-3</b>
80mm (3") QISJAX Pipe Clamp	<b>AC3-3</b>
100mm (4") QISJAX Pipe Clamp	<b>AC4-3</b>
125mm (5") QISJAX Pipe Clamp	<b>AC5-3</b>
50mm (2") QISJAX Vee Rubber Slow Drain	<b>J1630</b>
80mm (3") QISJAX Vee Rubber Slow Drain	<b>E4399</b>
100mm (4") QISJAX Vee Rubber Slow Drain	<b>E4400</b>
125mm (5") QISJAX Vee Rubber Slow Drain	<b>E4401</b>
50mm (2") QISJAX Vee Rubber Fast Drain	<b>AC2-61</b>
80mm (3") QISJAX Vee Rubber Fast Drain	<b>E6010</b>
100mm (4") QISJAX Vee Rubber Fast Drain	<b>E6137</b>
50mm (2") QISJAX O' Ring	<b>E4582</b>
80mm (3") QISJAX O' Ring	<b>J0361</b>
100mm (4") QISJAX O' Ring New Style 11/32" (8mm)Section	<b>E4476</b>
100mm (4") QISJAX O' Ring Old Style 1/4" (6mm)Section	<b>J0160</b>
125mm (5") QISJAX O'Ring	<b>E4429</b>
QISJAX Coupling Bolt & Nut	<b>AC63</b>
QISJAX Coupling Washer	<b>AC64</b>
125mm (5") QISJAX Cast Aluminium Stop End	<b>AC5-4</b>



PRODUCT	DESCRIPTION	CODE
---------	-------------	------

**READ HAND PRIMING PUMP**

**READ HAND PRIMING PUMP** (Without Galvanised Bracket)



Read Hand Priming Pump (One Only)

RHP

Read Hand Priming Pump ( Box of Three) (Price Each)  
Extra Discount for Box of Three

RHP

**READ HAND PRIMING PUMP SPARES**

Diaphragm

RHPA/3

Galvanised Mounting Bracket

RHPA/4

Fulcrum Collar

RHPA/5

40mm (1½") Back Nut

RHPA/6

Pump Handle

RHPA/7

Stainless Steel Eye Bolt, Nut & Washer

RHPA/8

Valve Cover Plate

RHPA/11

Valve Rubber

RHPA/12

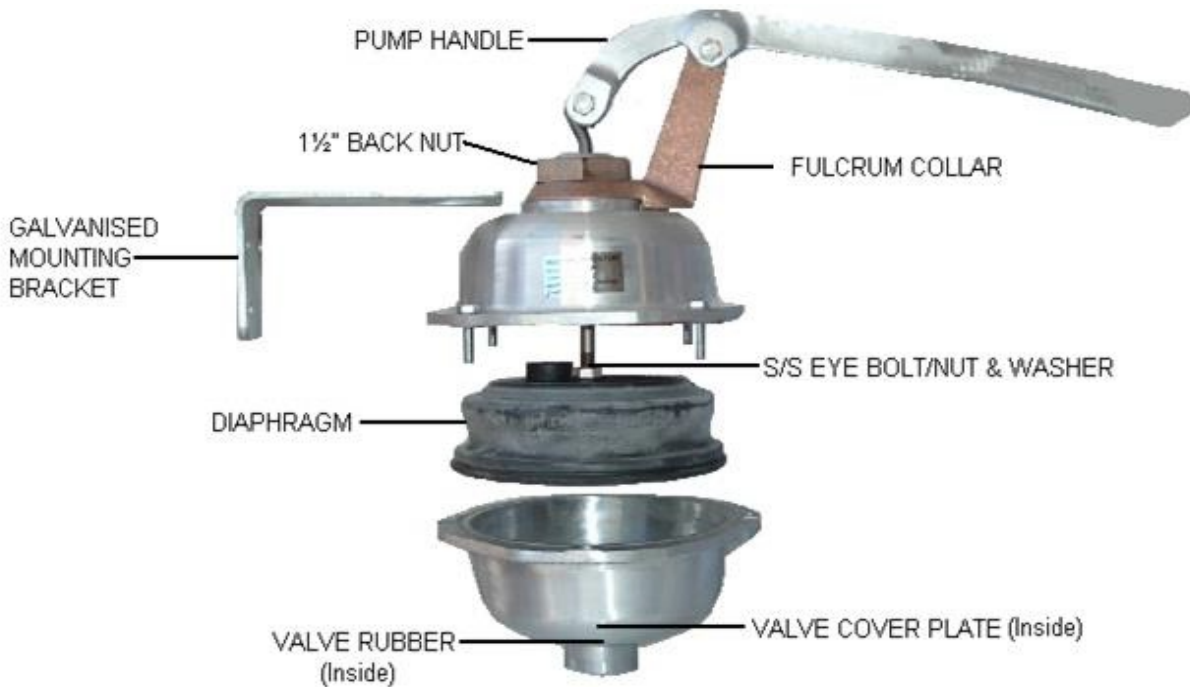

This "Read Hand Priming Pump" has a heavy duty polished Aluminium body with an Aluminium fulcrum collar. The Diaphragm is very solid rubber with a metal plate encompassed in the bottom for extra strength. Each Stroke displaces 1.9 litres of Air. The inlet is 1" BSP and has been beefed up around this area. The pump is not supplied with mounting bracket but this is available as a spare part if required.



PRODUCT	DESCRIPTION	CODE
---------	-------------	------

**QISJAX HAND PRIMING PUMP SPARES (Formerly AJAX)**

Discharge Casing	<b>DHP2</b>
Inlet Valve (Rubber)	<b>DHP24</b>
Hex Bolt - Casing Assembly	<b>DHP62</b>
Hex Nut - Casing Assembly	<b>DHP65</b>
Diaphragm	<b>DHP67</b>
Handle	<b>DHP72</b>

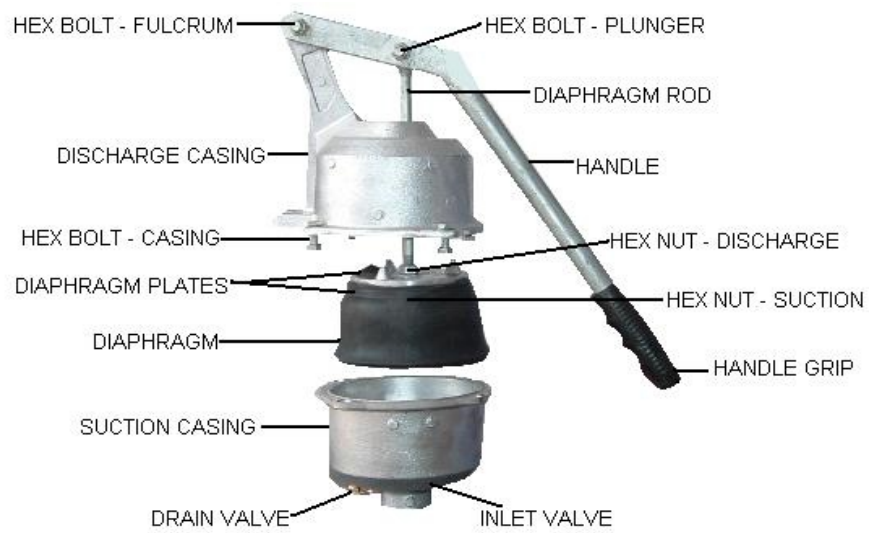

PRODUCT	DESCRIPTION	CODE
---------	-------------	------

**GASKETS, SEALS & SPRINGS**

**FLANGE GASKETS (Table "D" 3mm Rubber Insertion)**

	25mm (1") Flange Gasket	FG25
	32mm (1¼") Flange Gasket	FG32
	40mm (1½") Flange Gasket	FG40
	50mm (2") Flange Gasket	FG50
	65mm (2½") Flange Gasket	FG65
	80mm (3") Flange Gasket	FG80
	100mm (4") Flange Gasket	FG100
	125mm (5") Flange Gasket	FG125
	150mm (6") Flange Gasket	FG150
	200mm (8") Flange Gasket	FG200
	225mm (9") Flange Gasket	FG225
	250mm (10") Flange Gasket	FG250
	300mm (12") Flange Gasket	FG300
	350mm (14") Flange Gasket	FG350
	375mm (15") Flange Gasket	FG375
	400mm (16") Flange Gasket	FG400
	450mm (18") Flange Gasket	FG450
	500mm (20") Flange Gasket	FG500
	600mm (24") Flange Gasket	FG600

**CHINA PUMP GASKETS 3mm Rubber Insertion (CMC)**

	150mm (245 O.D. x 150 I.D. 6 Hole) CMC Gasket	QISCMC150
	200mm (335 O.D. x 200 I.D. 6 Hole) CMC Gasket	QISCMC200
	250mm (370 O.D. x 250 I.D. 8 Hole) CMC Gasket	QISCMC250
	300mm (430 O.D. x 300 I.D. 8 Hole) CMC Gasket	QISCMC300
	400mm (560 O.D. x 430 I.D. 8 Hole) CMC Gasket	QISCMC400

**AC GIBAULT O-RINGS**

See Gibault O-Ring Listing

Page 39

**AC OLD STYLE PIPE JOINT O' RING**

	100mm (4") A.C. Pipe Joint Ring	O.D. SEC	5¼" ½"	E6067
--	---------------------------------	----------	--------	-------

**AC SUPERTITE SOLID VEE RUBBERS**

	100mm (4") A.C. Supertite Vee Rubber	QISV100
	150mm (6") A.C. Supertite Vee Rubber	QISV150
	200mm (8") A.C. Supertite Vee Rubber	QISV200

**AIM COUPLING VEE RUBBERS**

2", 3", 4" & 5" use "FL" Vee Rubbers

Page 38

	150mm (6") Vee Rubber	AIM6
--	-----------------------	------

**AJAX ALUMINIUM COUPLING RUBBERS**

Use QISJAX Rubbers

Page 34

**AJAX SOLID SET VEE RUBBER**

	32mm (1¼") QISJAX Solid Set Vee Rubbers	QISJAX125
--	---	-----------

**AMES VEE RUBBERS**

Use QAMES Vee Rubbers

Page 41

**AMES SPRINGS**

Use QAMES Springs

Page 41

PRODUCT	DESCRIPTION	CODE
---------	-------------	------



**GASKETS, SEALS & SPRINGS**

**A.S.L. VEE RUBBERS**

	80mm (3") A.S.L. Vee Rubber	ASL3
	100mm (4") A.S.L. Vee Rubber - <b>No longer available</b>	ASL4
	125mm (5") A.S.L. Vee Rubber	ASL5

**BALTIC SIMPLEX RUBBERS**

	80mm (3") Baltic Simplex O'Ring	J0361
	80mm (3") Baltic Simplex Vee Rubber	E6566
	100mm (4") Baltic Simplex Vee Rubber	E4400

**BUZZACOTT IRRIGATION RUBBERS**

	80mm (3") Buzzacott Rubber	IR13
	100mm (4") Buzzacott Rubber	IR14
	125mm (5") Buzzacott Rubber	IR15

**CHAMSA SPANISH SOLID SET RUBBERS**

	50mm (2") Chamsa Spanish Solid Set Vee Rubber	IBC200
--	---	--------

**CHERAS ALUMINIUM COUPLING RUBBERS**

Use "FL" Vee Rubbers Page 38 Below

**CUSTOM ALUMINIUM COUPLING RUBBERS**

See Custom Coupling Spares Page 33

**DIAMOND Y VEE RUBBERS**

	80mm (3") Diamond Y Vee Rubber	C44180
	100mm (4") Diamond Y Vee Rubber	C441100
	125mm (5") Diamond Y Vee Rubber	C441125

**FIELDLOK ALUMINIUM COUPLING RUBBERS**

Use "FL" Vee Rubbers Page 38 Below

**"FL" VEE RUBBERS (To suit Pope Flexalite, I.B.C. Fastlok, Fieldlok and AIM irrigation Couplings)**

<b>Medium Drain</b>		
	50mm (2") "FL" Vee Rubber	FL2M
	80mm (3") "FL" Vee Rubber	FL3M
	100mm (4") "FL" Vee Rubber	FL4M
	125mm (5") "FL" Vee Rubber (Also Suits Pope Heavy Duty Couplings)	FL5M
<b>Non Drain</b>		
	50mm (2") "FL" Vee Rubber	FL2ND
	80mm (3") "FL" Vee Rubber	FL3ND
	100mm (4") "FL" Vee Rubber	FL4ND
	125mm (5") "FL" Vee Rubber (Also Suits Pope Heavy Duty Couplings)	FL5ND
	150mm (6") "FL" Vee Rubber (Also Suits Pope Heavy Duty Couplings)	FL6ND

**FLOOD GATE BOTTOM SILL RUBBER**

	Flood Gate Bottom Sill Rubber (Price per Metre)	E2877	P.O.A
	For use in conjunction with E2766 seal rubber as the bottom seal on fabricated flood or sluice valves, available in multiple metre lengths up to 20 metres in one piece.		

**FLOOD GATE SIDE SEAL RUBBER**



	Flood Gate Side Seal Rubber (Price Per Metre)	E2766	P.O.A
	This Product is only available in either 10m or 20m lengths. It is used as the side sealing channel on fabricated flood or sluice valves and is designed to seal on 1/4" M.S. Plate.		



PRODUCT	DESCRIPTION	CODE
---------	-------------	------

**GASKETS, SEALS & SPRINGS**

**GIBAULT O" RINGS**

	<b>Suit A.C. Fittings</b>	<b>I.D.</b>	<b>SECTION</b>	
	80mm (3") Gibault O' Ring AC	76mm	12.5mm	<b>F3</b>
	100mm (4") Gibault O' Ring AC	104mm	16mm	<b>F4</b>
	150mm (6") Gibault O' Ring AC	155mm	16mm	<b>F6</b>
	200mm (8") Gibault O' Ring AC	213mm	16mm	<b>F8</b>
	<b>Suit Milnes Aluminium/PVC Fittings</b>	<b>I.D.</b>	<b>SECTION</b>	
	65mm (2½") Gibault O' Ring Milnes PVC	73mm	11mm	<b>F2.5M</b>
	80mm (3") Gibault O' Ring Milnes PVC	86mm	13mm	<b>F3M</b>
	100mm (4") Gibault O' Ring Milnes PVC	111mm	16mm	<b>F4M</b>
	125mm (5") Gibault O' Ring Milnes PVC	136mm	14mm	<b>F5M</b>
	150mm (6") Gibault O' Ring Milnes PVC	161mm	16mm	<b>F6M</b>
	200mm (8") Gibault O' Ring Milnes PVC	220mm	12mm	<b>F8M</b>

**GRASSLANDS COUPLING O' RINGS**

	50mm (2") Grasslands O' Ring			<b>GRO2</b>
	80mm (3") Grasslands O' Ring			<b>GRO3</b>
	100mm (4") Grasslands O' Ring			<b>E4476</b>
	125mm (5") Grasslands O' Ring			<b>E5492</b>

**GRASSLANDS COUPLING VEE RUBBERS**

	50mm (2") Grasslands Vee Rubber			<b>SR2</b>
	80mm (3") Grasslands Vee Rubber			<b>SR3</b>
	100mm (4") Grasslands Vee Rubber			<b>FL4ND</b>
	125mm (5") Grasslands Vee Rubber			<b>CM5ND</b>

**IBC FASTLOK & QUICKLATCH VEE RUBBERS**

Use "FL" Vee Rubbers

Page 38

**"I.B.C. CROPSET" VEE RUBBERS**

	32mm (1¼") "I.B.C. Cropset" Vee Rubber			<b>IBC125</b>
	40mm (1½") "I.B.C. Cropset" Vee Rubber			<b>IBC150</b>
	50mm (2") "I.B.C. Cropset" Vee Rubber			<b>IBC200</b>



**I.B.C. OLD STYLE "LEVER" COUPLING RUBBERS (Note: These Rubbers have a Bevel on one face)**

		<b>O.D.</b>	<b>I.D.</b>	<b>HT.</b>	
	80mm (3") I.B.C. Rubber	3¾"	3⅛"	7/16"	<b>IR23</b>
	100mm (4") I.B.C. Rubber	4 <sup>13</sup> / <sub>16</sub> "	4 <sup>3</sup> / <sub>16</sub> "	7/16"	<b>IR24</b>

**IRRIFRANCE POLY SOLID SET COUPLING RUBBERS**

	50mm (2") Poly Solid Set Vee Rubber			<b>IBC200</b>
--	-------------------------------------	--	--	---------------

**IEC RUBBERS**

	<b>IEC Bend Rubber</b>	<b>O.D.</b>	<b>I.D.</b>	<b>HT.</b>	
	80mm (3") IEC Bend Rubber	110	89	12	<b>IEC42</b>
	100mm (4") IEC Bend Rubber	127	107	15	<b>IEC43</b>
	125mm (5") IEC Bend Rubber	154	137	14	<b>IEC44</b>
	<b>IEC Valve Rubber</b>	<b>O.D.</b>	<b>I.D.</b>	<b>HT.</b>	
	100mm (4") x 80mm (3") IEC Valve Rubber	124	70	5	<b>IEC09</b>
	100mm (4") x 100mm (4") IEC Valve Rubber	123	94	5	<b>IEC10</b>
	150mm (6") x 80mm (3") IEC Valve Rubber	145	73	5	<b>IEC11</b>
	150mm (6") x 100mm (4") IEC Valve Rubber	144	101	5	<b>IEC12</b>
	150mm (6") x 125mm (5") IEC Valve Rubber	142	111	5	<b>IEC13</b>

**LANE & BOWLER 6" VEE RUBBER**

Use AIM6 Vee Rubber

**AIM6**

PRODUCT	DESCRIPTION	CODE
---------	-------------	------

**GASKETS, SEALS & SPRINGS**

**McCAREY RUBBERS**



80mm (3") **McCarey** Bend Rubber  
 100mm (4") **McCarey** Bend Rubber  
 125mm (5") **McCarey** Bend Rubber

**MHBR80**  
**MHBR100**  
**MHBR125**



100mm (4") **McCarey** New Valve Rubber

**MR100**

**McDOWELL VEE RUBBERS & SPRINGS**

**Springs**



80mm (3") **McDowell** Spring  
 100mm (4") **McDowell** Spring  
 125mm (5") **McDowell** Spring  
 150mm (6") **McDowell** Spring

**MDSP80**  
**MDSP100**  
**MDSP125**  
**MDSP150**

**Vee Rubbers**

80mm (3") **McDowell** Vee Rubber  
 100mm (4") **McDowell** Vee Rubber  
 125mm (5") **McDowell** Vee Rubber  
 150mm (6") **McDowell** Vee Rubber

**MCD80**  
**MCD100**  
**MCD125**  
**MCD150**

**MILNES ALUMINIUM GIBALT RUBBERS TO SUIT PVC PIPE**

Use Gibalt Rubbers

**Page 39**

**MOFFAT VIRTUE OLD STYLE COUPLING RUBBERS**



80mm (3") Moulded with Bevel on Both Faces  
 100mm (4") Moulded with Bevel on Both Faces

**IR53**  
**IR54**

**POPE FLEXALITE ALUMINIUM COUPLING VEE RUBBERS**

Use "FL" Vee Rubbers

**Page 38**

**POPE LEVERLOK OLD STYLE COUPLING RUBBERS**

Use Buzzacott Coupling Rubber

**Page 38**

**POPE MUSHROOM VALVE RUBBER**



Mushroom Valve Rubber  
 1 3/4" Daim x 5/8" Dome w/- 1/4" Hole

**E5126**

**POPE NEW STYLE RIGID COUPLING RUBBERS**



100mm (4") Rigid Coupling Rubber  
 125mm (5") Rigid Coupling Rubber

**PRCN4**  
**PRCN5**

**POPE OLD STYLE RIGID COUPLING RUBBERS**



100mm (4") Rigid Coupling Rubber  
 125mm (5") Rigid Coupling Rubber

**PRC4**  
**PRC5**

**POPE SIDE ROLL DRAIN VALVE RUBBER**



Pope Side Roll Drain Valve Rubber

**PSD1**

PRODUCT	DESCRIPTION	CODE
---------	-------------	------

**GASKETS, SEALS & SPRINGS**

**QAMES VEE RUBBERS & SPRINGS (To suit Ames Irrigation Coupling)**

**Vee Rubber's**



50mm (2") <b>QAMES</b> Vee Rubber	<b>E5441</b>
80mm (3") <b>QAMES</b> Vee Rubber	<b>E5442</b>
100mm (4") <b>QAMES</b> Vee Rubber	<b>E5443</b>
125mm (5") <b>QAMES</b> Vee Rubber	<b>E5444</b>

**Springs**

50mm (2") <b>QAMES</b> Springs	<b>SP2</b>
80mm (3") <b>QAMES</b> Springs	<b>SP3</b>
100mm (4") <b>QAMES</b> Springs	<b>SP4</b>
125mm (5") <b>QAMES</b> Springs	<b>SP5</b>

**QISCROSS HAND PRIMER DIAPHRAGM (Southern Cross)**



Diaphragm for Southern Cross Hand Priming Pump	<b>SXDIA</b>
--	--------------

**QISCROSS END TOW DRAIN VALVE RUBBER (Southern Cross)**



<b>QISCROSS</b> End Tow Drain Valve Rubber	<b>E7448</b>
--	--------------

**QISCROSS O' RINGS (To Suit Southern Cross KB & KL Couplings)**



50mm (2") Use <b>QISJAX</b> (7mm section)	<b>E4582</b>
80mm (3") Use <b>QISJAX</b> (6mm section)	<b>J0361</b>
100mm (4") Use <b>QISJAX</b> (8mm section)	<b>E4476</b>
125mm (5") <b>QISCROSS</b> O' Ring (8mm section)	<b>E5492</b>

**QISCROSS O' RINGS (Thick O' Ring to suit Southern Cross NT couplings)**



80mm (3") <b>QISCROSS</b> Thick O' Ring (12mm)	<b>E6705</b>
100mm (4") <b>QISCROSS</b> Thick O' Ring (12mm)	<b>E6706</b>
125mm (5") <b>QISCROSS</b> Thick O' Ring (12mm)	<b>E6707</b>

**QISCROSS VEE RUBBERS (To suit Southern Cross KB, KL & NT and Webbway Mk II Irrigation Couplings)**



40mm (1½") <b>QISCROSS</b> Solid Set Vee Rubber	<b>RJ150</b>
50mm (2") <b>QISCROSS</b> Vee Rubber	<b>E4670</b>
80mm (3") <b>QISCROSS</b> Vee Rubber	<b>E4671</b>
100mm (4") <b>QISCROSS</b> Vee Rubber	<b>E4672</b>
125mm (5") <b>QISCROSS</b> Vee Rubber	<b>E4665</b>
150mm (6") <b>QISCROSS</b> Vee Rubber	<b>E5753</b>

**QISJAX O' RINGS (Formerly AJAX)**



See QISJAX Coupling Spares	<b>Page 34</b>
----------------------------	----------------

**QISJAX VEE RUBBERS (Formerly AJAX)**



See QISJAX Coupling Spares	<b>Page 34</b>
----------------------------	----------------

**RAINBOW COUPLING O-RINGS AND VEE RUBBERS**



80mm (3") <b>Rainbow MK1</b> Coupling O' Ring	<b>RB13</b>
100mm (4") <b>Rainbow MK1</b> Coupling O' Ring	<b>RB14</b>
125mm (5") <b>Rainbow MK1</b> Coupling O' Ring (Same as Above)	<b>RB14</b>



80mm (3") <b>Rainbow MK2</b> Vee Rubber	<b>RB23</b>
100mm (4") <b>Rainbow MK2</b> Vee Rubber	<b>RB24</b>
125mm (5") <b>Rainbow MK2</b> Vee Rubber	<b>RB25</b>

PRODUCT	DESCRIPTION	CODE
---------	-------------	------

### GASKETS, SEALS & SPRINGS

#### "RJ" VEE RUBBERS (To suit "RJ" Solid Set Couplings)



32mm (1¼") "RJ" Vee Rubber	RJ125
40mm (1½") "RJ" Vee Rubber	RJ150
50mm (2") "RJ" Vee Rubber Medium Drain	FL2M
50mm (2") "RJ" Vee Rubber Non-Drain	FL2ND

#### SALEPLAS VEE RUBBER

50mm (2") Vee Rubber	IBC200
----------------------	--------

#### SHUR-RANE O' RINGS



50mm (2") Shur-Rane O' Ring	SRO2
80mm (3") Shur-Rane O' Ring	SRO3
100mm (4") Shur-Rane O' Ring	SRO4
125mm (5") Shur-Rane O' Ring	SRO5

#### SHUR-RANE VEE RUBBERS



50mm (2") Shur-Rane Vee Rubber	SR2
80mm (3") Shur-Rane Vee Rubber	SR3
100mm (4") Shur-Rane Vee Rubber	SR4
125mm (5") Shur-Rane Vee Rubber	SR5

#### SIPPEL COUPLING RUBBERS, VEE RUBBERS AND O-RINGS



80MM (3") Coupling Vee Rubber	FL3ND
100mm (4") Coupling Vee Rubber	E5732
100mm (4") Coupling O-Ring	E4476

#### SKYRANE VEE RUBBER



100mm (4") Vee Rubber use Diamond Y 100mm (4")	C441100
--	---------

#### SNAPLOK MK 1 COUPLING RUBBERS

Use Webbway MK 1	Page 43
------------------	---------

#### SNAPLOK MK 2 COUPLING VEE RUBBERS

Use QISCROSS Vee Rubbers	Page 41
--------------------------	---------

#### SOUTHERN CROSS RUBBERS AND O-RINGS



Southern Cross KB, KL & NT Coupling Vee Rubbers use QISCROSS Vee Rubbers	Page 41
--	---------

Southern Cross KB & KL Coupling O-Rings use QISCROSS O-Rings	Page 41
--	---------

Southern Cross NT Coupling O-Ring use QISCROSS Thick O-Rings	Page 41
--	---------



Southern Cross HP (Cheras) Coupling use "FL" Vee Rubbers	Page 38
--	---------

Southern Cross Priming Pump Diaphragm Rubber use QISCROSS	Page 41
---	---------

Southern Cross Hydrant Rubbers and Spares use QISCROSS	Page 27
--	---------



Southern Cross End Tow Drain Valve Rubber use QISCROSS	Page 41
--	---------

#### THUNDER BIRD SIDE ROLL GASKETS



100mm (4") Thunderbird Side Roll Gasket	TR100G
125mm (5") Thunderbird Side Roll Gasket	TR125G

#### TRAILCO OLD STYLE T250 IRRIGATOR RUBBER



T250 Irrigator Rubber use FL3ND	FL3ND
---------------------------------	-------



PRODUCT	DESCRIPTION	CODE
---------	-------------	------

**GASKETS, SEALS & SPRINGS**

**UNIVERSAL (AJAX STYLE) COUPLING RUBBERS**



80mm (3") Universal Vee Rubber use Baltic Simplex **E6566**  
 100mm (4") Universal Vee Rubber use QISJAX **E4400**  
 125mm (5") Universal Vee Rubber use QISJAX **E4401**

80mm (3") Universal O-Ring use QISJAX O-Ring **J0361**

**WADE RAIN COUPLING AND SIDE ROLL RUBBERS**



100mm (4") **Wade Rain** Coupling Gasket **WR10-6-4**



Wade Rain **Power Roll Gasket** 4.5" **WR10-6-4.5**



100mm (4") Wade Rain Bolt on End Coupler Gasket  
 While Stocks Last **WR10-6-4J**

**WEBBWAY MK1 COUPLING RUBBERS**



80mm (3") **Webbway MK1** Coupling Rubber **WW3**  
 100mm (4") **Webbway MK1** Coupling Rubber **WW4**  
 125mm (5") **Webbway MK1** Coupling Rubber **WW5**

**WEBBWAY MK2 COUPLING VEE RUBBERS**



Use QISCROSS Vee Rubbers **Page 41**

**RUBBERS TO SUIT BLUE MAINLINE FITTINGS**

**WHITE SERIES 1 PVC**



100mm (4") White Series 1 PVC Rubber **RS100**  
 150mm (6") White Series 1 PVC Rubber **RS150**  
 200mm (8") White Series 1 PVC Rubber **RS200**

**Blue Series 2 PVC, Fibro, AC and Ductile Iron**

100mm (4") Fibro, AC, DI, Series 2 PVC Rubber **RS100F**  
 150mm (6") Fibro, AC, DI, Series 2 PVC Rubber **RS150F**  
 200mm (8") Fibro, AC, DI, Series 2 PVC Rubber **RS200F**



# *Irrigation Hydrants & Spares*



*For assistance locating a distributor, contact Michael: 0488 917 285 or  
micheal@irrigationdirect.com.au*