

RIVULIS VALVES



Rivulis has a range of air valves, vacuum breakers, plastic and metal hydraulic valves, valve accessories (solenoids, fittings and spare parts), hydraulic control tube and pressure gauges.







AIR VALVES





Vacuum Breakers

Material Properties	Sizes	Minimum Pressure	Maximum Pressure	Manufactured by
Corrosion-Resistant UV Protection	20 mm (¾") 25 mm (1") 50 mm (2") 80 mm (3")	20 kPa (0.2bar)	1,000 kPa (10 bar)	A.R.I (AV-10)

Product Number	Description	
101005649	15 mm (½") Plastic Vacuum Breaker (BSP Male) AV-10	
101045527	20 mm (¾") Plastic Vacuum Breaker (BSP Male) AV-10	
101045529	25 mm (1") Plastic Vacuum Breaker (BSP Male) AV-10	
101045531	50 mm (2") Plastic Vacuum Breaker (BSP Female) AV-10	
101045533	80 mm (3") Plastic Vacuum Breaker (BSP Female) AV-10	

Automatic Air Valves

Material Properties	Sizes	Minimum Pressure	Maximum Pressure	Manufactured by
Corrosion-Resistant UV Protection	15 mm (½") 20 mm (¾") 25 mm (1")	20 kPa (0.2 bar)	1,000 kPa (10 bar)	A.R.I (SG-10)

Product Number	Description	
WT12508	Rivulis 15 mm (½") Automatic Air Valve (BSP Male) SG-10	
WT12510	Rivulis 20 mm (¾") Automatic Air Valve (BSP Male) SG-10	
WT12512	Rivulis 25 mm (1") Automatic Air Valve (BSP Male) SG-10	

AIR VALVES



Barak Combination Air Valves

Material Properties	Sizes	Manufactured by
Corrosion-Resistant UV Protection	20 mm (¾") 25 mm (1") 50 mm (2")	A.R.I

Product Number	Description
101005647	ARI BARAK DG-10 20 mm Grey Line (BSP Male)
101005643	ARI BARAK DG-10 25 mm Grey Line (BSP Male)
101005635	ARI BARAK DG-10 50 mm Grey Line (BSP Male)
101005627	ARI BARAK D-040 25 mm Black Line (BSP Male)
101005629	ARI BARAK D-040 50 mm Black Line (BSP Male)



Rivulis Combination Air Valves

Material Properties	Sizes	Maximum Pressure	Manufactured by
Corrosion-Resistant UV Protection	15 mm (½") 20 mm (¾") 25 mm (1") 50 mm (2")	1,000 kPa (10 bar)	A.R.I (D-43)

Product Number	Description
WT12514	Rivulis 15 mm (½") Combination Dual Action Air Valve (BSP Male)
WT12516	Rivulis 20 mm (¾") Combination Dual Action Air Valve (BSP Male)
WT12518	Rivulis 25 mm (1") Combination Dual Action Air Valve (BSP Male)
WT12520	Rivulis 50 mm (2") Combination Dual Action Air Valve (BSP Female) D-43

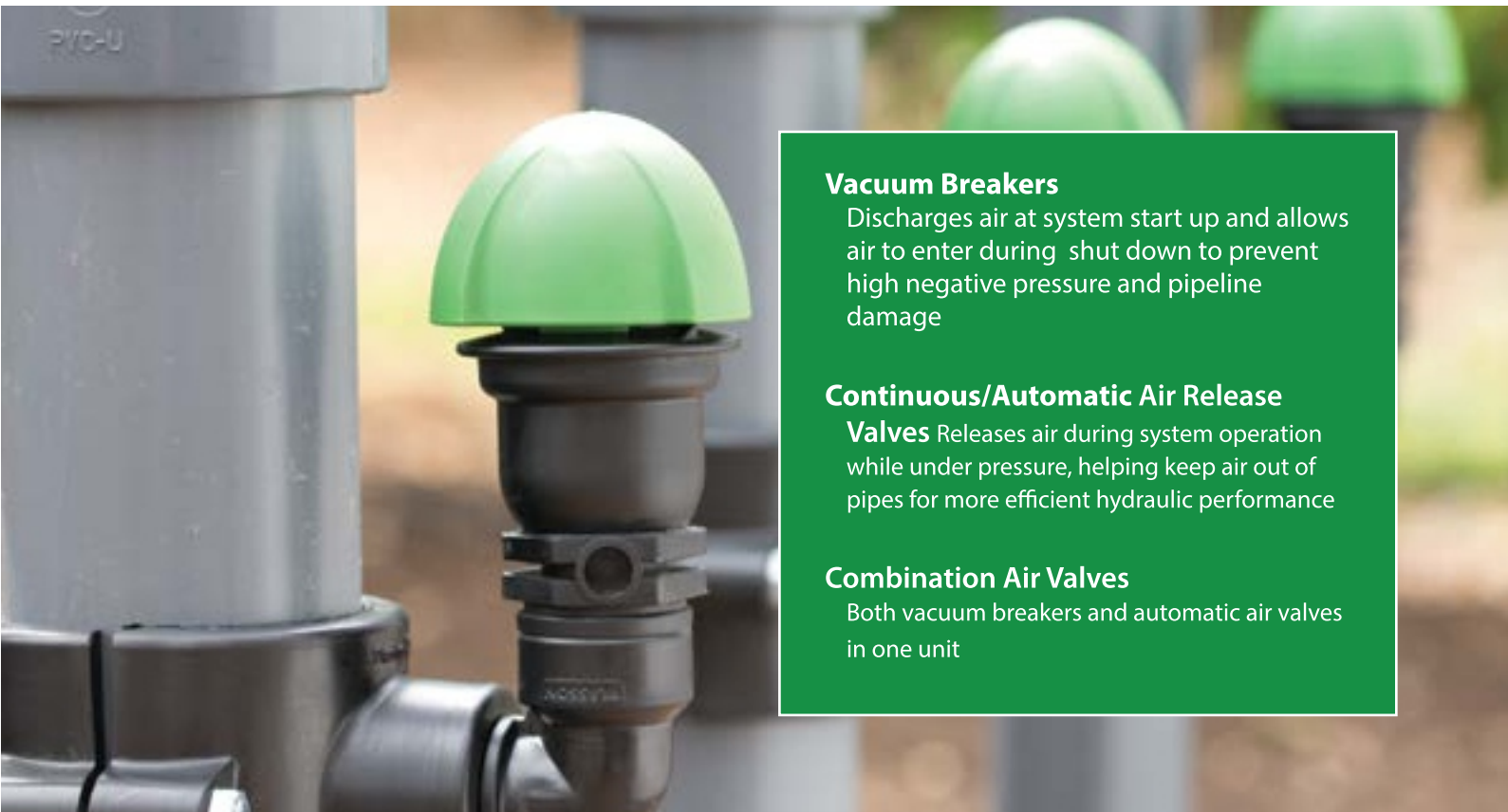

Vacuum Breakers

Discharges air at system start up and allows air to enter during shut down to prevent high negative pressure and pipeline damage

Continuous/Automatic Air Release Valves

Releases air during system operation while under pressure, helping keep air out of pipes for more efficient hydraulic performance

Combination Air Valves

Both vacuum breakers and automatic air valves in one unit

PLASTIC VALVES



Sizes	Configurations	Operating Range	Pilots Spring Options	End Connections	Standard Springs
40mm - 150mm	Straight & Angle	50 - 1,000 kPa	20 - 170 kPa 50 - 300 kPa 80 - 650 kPa	BSP / BSTD	80 - 650 kPa

Plastic Valves | 40mm - 80mm Straight Valves

Valve Description	40 mm (1 1/2") Threaded (BSP)	50 mm (2") Threaded (BSP) (Long)	80 mm (3") Threaded (BSP)
	Product Number	Product Number	Product Number
Basic - Valve Body	101046809	WT12004	WT12007
Manual Control Valve with 3-way Sagiv	101046815	WT12014	WT12017
Pressure Reducing (PR) Valve	101042680	WT12057	WT12059
Pressure Sustaining (PS) Valve	101046822	101046703	101034567
Electric on/off Valve (24VAC)	101046842	WT12025	WT12027
Pressure Reducing Valve with 24VAC Solenoid	101046829	WT12089	WT12091
Pressure Reducing Valve with Latching Solenoid	-	WT12105	WT12107
Pressure Reducing Valve with Hydraulic Relay (Galit)	-	WT12153	WT12155

All valves are supplied with 3-way Sagiv & NC as standard

Plastic Valves | 80mm (Long) - 150mm Straight Valves

Valve Description	80 mm (3") Threaded (Long)	80 mm (3") Flanged (Long)	100 mm (4") Flanged	150 mm (6") Flanged
	Product Number	Product Number	Product Number	Product Number
Basic - Valve Body	WT12009	WT12919	WT12920	WT12010
Manual Control Valve with 3-way Sagiv	WT12019	WT12921	WT12922	WT12020
Pressure Reducing (PR) Valve	WT12063	WT12064	WT12066	WT12068
Pressure Sustaining (PS) Valve	101048298	AUV23LPS	101048292	101048293
Electric on/off Valve (24VAC)	WT12031	WT12032	WT12034	WT12036
Pressure Reducing Valve with 24VAC Solenoid	WT12095	WT12096	WT12098	WT12100
Pressure Reducing Valve with Latching Solenoid	WT12111	WT12112	WT12114	WT12116
Pressure Reducing Valve with Hydraulic Relay (Galit)	WT12159	WT12160	WT12162	WT12164

All valves are supplied with 3-way Sagiv & NC as standard

PLASTIC VALVES

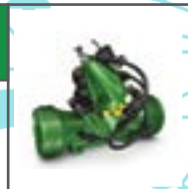

Plastic Valves | 50mm - 80mm Angle Valves

Valve Description	50 mm (2") Threaded (BSP)	80 mm (3") Threaded (BSP)	80 mm (3") Threaded (Long)
	Product Number	Product Number	Product Number
Basic - Valve Body	AUV2ABA	101046810	101046811
Manual Control Valve with 3-way Sagiv	AUV2A3W	101034226	101018859
Pressure Reducing (PR) Valve	AUV2APR	101034365	101045449
Pressure Sustaining (PS) Valve	AUV2APS	101048297	101046788
Electric on/off Valve with 3-way Sagiv (24VAC)	AUV2AEL	101046780	101046782
Pressure Reducing Valve with 24VAC Solenoid	AUV2APRE	AUV3PREA	AUV3LPREA

All valves are supplied with 3-way Sagiv & NC as standard

Plastic Valves | 50mm - 80mm Angle Valves

Valve Description	80 mm (3") (Long) Flanged	100 mm (4") Flanged
	Product Number	Product Number
Basic - Valve Body	101046812	101046813
Manual Control Valve with 3-way Sagiv	101046777	101046779
Pressure Reducing (PR) Valve	101046785	101018915
Pressure Sustaining (PS) Valve	101046789	101046790
Electric on/off Valve with 3-way Sagiv (24VAC)	101046783	101046784
Pressure Reducing Valve with 24VAC Solenoid	AUV3APREF	AUV4APREF

All valves are supplied with 3-way Sagiv & NC as standard

METAL VALVES



Sizes	Configurations	Operating Range	Pilot Spring Options	End Connections	Standard Spring
40mm - 300mm	Straight & Angle	50 - 600 kPa	50 - 300 kPa 80 - 650 kPa 100 - 1,600 kPa	BSP/BSTD	80 - 650 kPa (up to 4") 100 - 1,600 kPa (6" - 12")

Metal Valves | 40mm - 80mm Straight Valves

Valve Description	40 mm (1 1/2") Threaded (BSP)	50 mm (2") Threaded (BSP)	80 mm (3"x2.5"x3") Threaded (BSP)
	Product Number	Product Number	Product Number
Basic - Valve Body	101018818	WT12241	101018791
Manual Control Valve with 3-way Sagiv	101046814	WT12262	101018849
Pressure Reducing (PR) Valve	101046816	WT12283	101034326
Pressure Sustaining (PS) Valve	101046819	WT14239	101046820
Pressure Reducing and Pressure Sustaining	101048269	WT12304	101048286
Level Control Valve with Plastic Float	101046830	101048270	-
Quick Relief Valve - 2-way	101046835	WT12367	-
Electric Control Valve with 24VAC Solenoid	101034651	WT14402	101046836
Pressure Reducing Valve with 24VAC Solenoid			101019001

All valves are supplied with 3-way Sagiv & NC as standard. Hydraulic relay and other configurations are available upon request.

Metal Valves | 80mm - 100mm Straight Valves

Valve Description	80 mm (3") Threaded	80 mm (3") Flanged	100 mm (4") Flanged
	Product Number	Product Number	Product Number
Basic - Valve Body	WT12243	WT12244	WT12248
Manual Control Valve with 3-way Sagiv	WT12264	WT12265	WT12269
Pressure Reducing (PR) Valve with 3-way Sagiv	WT12285	WT12286	WT12290
Pressure Sustaining (PS) Valve with 3-way Sagiv	WT14242	WT14243	WT14247
Pressure Reducing and Pressure Sustaining with 3-way Sagiv	WT12306	WT12307	WT12311
Quick Relief Valve - 2-way	101046831	101046832	101046833
Electric Control Valve with 24VAC Solenoid	WT14404	WT14405	WT14409
Pressure Reducing Valve with 24VAC Solenoid	WT12327	WT12328	WT12332
Level Control Valve with Plastic Float	101048272	101048273	101048274
Dual Level Control Float Valve	101048580	101034856	101048281

All valves are supplied with plastic pilots and plastic fittings.
Max. operating pressure 10 bar
Contact your local Rivulis Representative for alternative pressures.

METAL VALVES

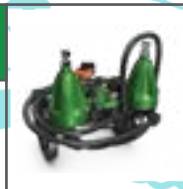

Metal Valves | 150mm - 300mm Straight Valves

Valve Description	150 mm (6") Flanged	200 mm (8") Flanged	250 mm (10") Flanged	300 mm (12") Flanged
	Product Number	Product Number	Product Number	Product Number
Basic - Valve Body	WT12252	WT12255	WT12258	101046808
Manual Control Valve with 3-way Sagiv	WT12273	WT12276	WT12279	-
Pressure Reducing (PR) Valve	WT12294	WT12297	WT12300	101048287
Pressure Sustaining (PS) Valve	WT14250	WT14253	WT14237	101046821
Pressure Reducing and Pressure Sustaining with 3-way Sagiv	WT12315	WT12318	WT12321	101046824
Quick Relief Valve 2-way	101034758	101048280	-	-
Electric Control Valve with 24VAC Solenoid	WT14413	101046837	101046838	101046839
Pressure Reducing Valve with 24VAC Solenoid	WT12335	WT12339	WT12342	101046828
Level Control Valve with Plastic Float	AUV6LC	AUV8LC	-	-
Dual Level Control Float Valve		101048283	101048284	101048285

6" - 12" Electric Valves are supplied with Gemsol Solenoids, 110 VAC solenoids are available at no extra cost.

All valves are supplied with brass pilots and fittings - rating 1,600 kPa

All valves are supplied with 3-way Sagiv & NC as standard. Hydraulic relay and other configurations are available upon request.

Metal Valves | 80mm - 100mm Angle Valves

Valve Description	50 mm (2") Threaded (BSP)	80 mm (3") Threaded (BSP)	80 mm (3") Flanged	100mm (4") Flanged
	Product Number	Product Number	Product Number	Product Number
Basic - Valve Body	WT14380	WT14382	101046716	WT14383
Pressure Reducing (PR) Valve with 3-way Sagiv	101018872	101018878	101018880	101018954
Electric Control Valve with 24VAC Solenoid	101019097	101046840	101046841	101048288
Pressure Reducing (PR) Valve with 24VAC Solenoid	101034653	101046827	101046825	101046826
Quick Relief Valve	101005117	WT12369	101046834	WT12370

RAF Plastic Valves

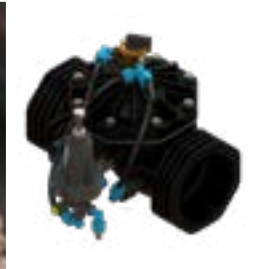

RAF-P Plastic Valves

RAF-P valves are recommended for use in irrigation and turf applications. Entirely manufactured from durable plastic materials, with state of the art patented diaphragm, the RAF-P valve offers the best corrosion resistance available in plastic technology with the streamlined, low friction hydraulic performance of the RAF metal valves.

RAF-P valves operate with a patented reinforced diaphragm, which eliminated the need for a metal spring. The special elastic design enables gradual, precise opening and closing of the valve, ideal for regulation purposes. By eliminating the metal spring, the RAF-P is virtually maintenance free.



Key Features

- Unique NON METAL WETTED PARTS valve
- Glass reinforced Nylon valve body and cover
- Streamlined flow with minimum head loss
- Simple and reliable three part valve, featuring body, cover and unique patented diaphragm

Key Benefits

- Uniform pressure distribution on sealing area, prevents diaphragm deformation and ensures maintenance free performance
- Smoothly operates in a wide range of pressure and flow, preventing noise and vibration
- Very low opening pressure and drip tight closing

Construction

Cover

The unique cover, with solid ribbed construction is made of glass reinforced Nylon.

Diaphragm

Springless patented diaphragm guarantees uniform pressure distribution on sealing area, prevents diaphragm deformation and ensures longer maintenance free operation.

Body

Weir type, straight flow, glass reinforced Nylon valve body.

Fasteners

Self retaining chrome plated steel nuts and hex stainless steel bolts enable easy access and are corrosion free.

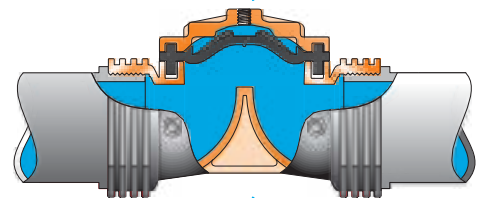
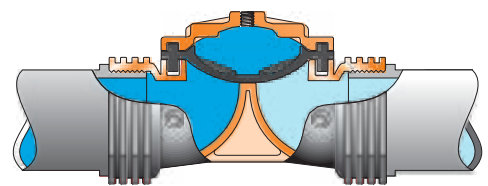

RAF-P VALVES



Technical specification

Threaded Valves

Valve Size		L	H	W	h	Weight	Max Flow	Flow @ $\Delta 0.1$ bar	Min Inlet Pressure	Control Chamber	Kv
mm	inch	mm	mm	mm	mm	kg	m ³ /h	m ³ /h	bar	L	(Fully Open)
40	1.5	185	105	125	32	0.7	20	17	0.5	0.1	53
50	2	194	110	125	38	0.8	25	17	0.5	0.1	53
80	3	240	152	160	58	1.4	45	23	0.5	0.2	72
80S	3x4x3	314	190	252	61	4.5	120	55	0.3	0.7	175
100	4	320	190	250	67	4.6	120	55	0.3	0.7	175

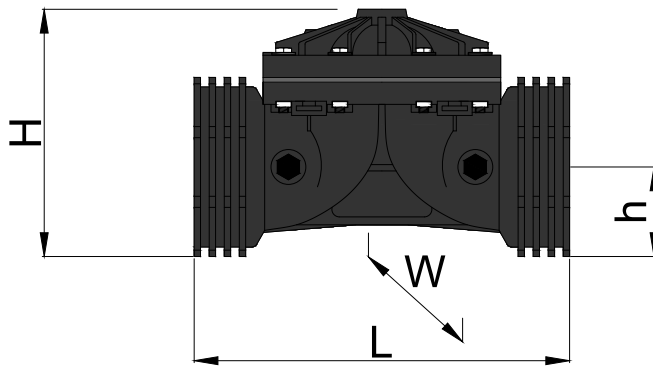

Flanged Valves

Valve Size		L	H	W	h	Weight	Max Flow	Flow @ $\Delta 0.1$ bar	Min Inlet Pressure	Control Chamber	Kv
mm	inch	mm	mm	mm	mm	kg	m ³ /h	m ³ /h	bar	L	(Fully Open)
80	3	400	194	200	100	2.2	45	23	0.5	0.2	72
80S	3x4x3	474	229	252	100	5.3	120	55	0.3	0.7	175
100	4	504	233	252	110	7.7	120	55	0.3	0.7	175

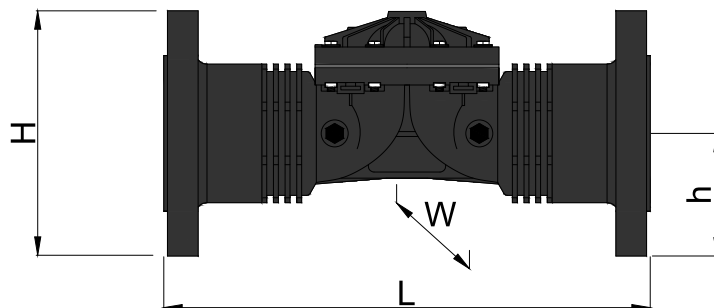

$$Q = Kv \sqrt{\Delta P}$$

$$\Delta P = (Q/Kv)^2$$

$$Q = m^3/h \quad \Delta P = \text{bar}$$

RAF-P VALVES





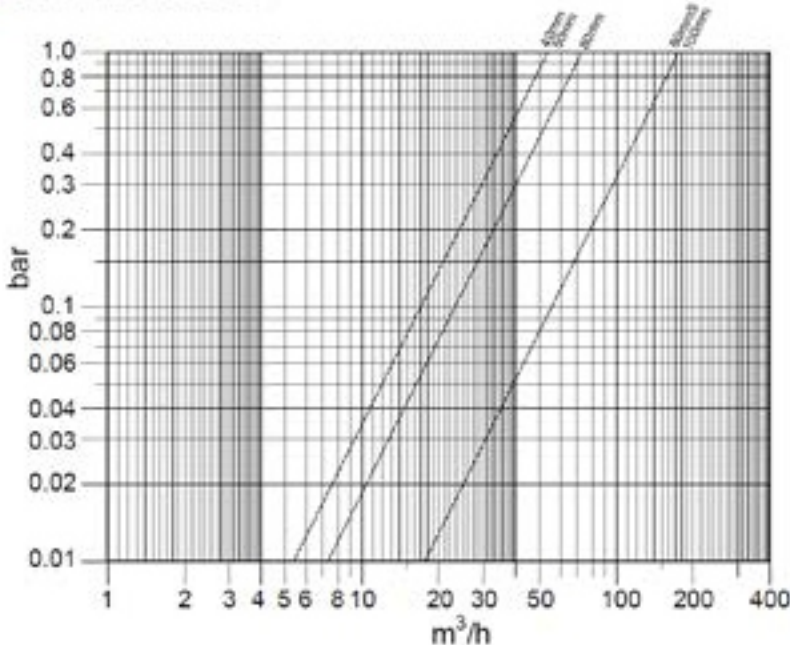





Flow Chart



All PRV & PSV Valves are supplied with RAF PR & PSR Pilot as standard. ARAD Pilot available on request

Pilot Selection Guide

Pilot Model	Pressure Rating	Recommend Valve Size	Spring Colour	Pressure Range (bar)	
PR Pilot 3-Way Pressure Reducing	PN10	1"-6" 25-150mm	Yellow	0.3 - 3.0	
			Green	0.5 - 4.5	
			Red	1 - 7.5	
PSR Pilot 3-Way Reducing/Sustaining	PN10	1"-6" 25-150mm	Yellow	0.3 - 3.0	
			Green	0.5 - 4.5	
			Red	1 - 7.5	
Arad Pilot 3-Way Reducing/Sustaining	PN10	1"-6" 25-150mm	Blue	0.5 - 1.5	
			Green	0.8 - 2.9	
			Grey	0.8-7.0	
P-683 Pilot 3-Way Reducing/Sustaining	PN16	1.5"-16" 40-400mm	Red	1.0-6.0	
			Green	1.5-9.0	
			Yellow	2.0-16	
P-162 Pilot 2-Way Pressure Reducing	PN16	1.5"-6" 25-150mm	Red	0.5-7.0	
			Green	1.5-12	
			Yellow	2.0-16	
P-161 Pilot 2-Way Pressure Reducing	PN16	6"-16" 150-400mm	Red	0.5-5.0	
			Green	1.0-9.0	
			Yellow	2.0-15	
P-182 Pilot 2-Way Pressure Sustaining	PN16	1.5"-6" 25-150mm	Red	0.5-5.0	
			Green	1.0-10	
			Yellow	2.0-16	
P-181 Pilot 2-Way Pressure Sustaining	PN16	6"-16" 150-400mm	Red	0.5-5.0	
			Green	1.0-10	
			Yellow	2.0-16	

RAF-P VALVES



RAF-P Plastic Basic Threaded Valves

Product Number	Size	Description
101071310	40mm	Plastic 1 1/2" Basic Valve - BSP
101071311	50mm	Plastic 2" Basic Valve - BSP
101071312	80mm	Plastic 3" Basic Valve - BSP
101071314	80mm	Plastic 3"S Basic Valve - BSP
101071316	100mm	Plastic 4" Basic Valve - BSP



RAF-P Plastic Basic Flanged Valves

Product Number	Size	Description
101071315	80mm	Plastic 3"S Basic Valve - Flanged
101071317	100mm	Plastic 4" Basic Valve - Flanged

Basic valve, pressure rating 10bar

RAF-P Plastic Threaded Valves with Manual 3-way Sagiv

Product Number	Size	Description
101071318	40mm	Plastic 1 1/2" Valve + 3-way Sagiv - BSP
101071319	50mm	Plastic 2" Valve + 3-way Sagiv - BSP
101071320	80mm	Plastic 3" Valve + 3-way Sagiv - BSP
101071322	80mm	Plastic 3"S Valve + 3-way Sagiv - BSP
101071324	100mm	Plastic 4" Valve + 3-way Sagiv - BSP



RAF-P Plastic Flanged Valves with Manual 3-way Sagiv

Product Number	Size	Description
101071323	80mm	Plastic 3"S Valve + 3-way Sagiv - Flanged
101071325	100mm	Plastic 4" Valve Flanged + 3-way Sagiv - Flanged

Plastic manual control valve with 3 way Sagiv, pressure rating 10bar

RAF-P VALVES



RAF-P Plastic Threaded Valves with 24VAC Solenoid 3-way

Product Number	Size	Description
101071326	40mm	Plastic 1 1/2" Valve 24VAC 3-way - BSP
101071327	50mm	Plastic 2" Valve 24VAC 3-way - BSP
101071328	80mm	Plastic 3" Valve 24VAC 3-way - BSP
101071330	80mm	Plastic 3"S Valve 24VAC 3-way - BSP
101071332	100mm	Plastic 4" Valve 24VAC 3-way - BSP



RAF-P Plastic Flanged Valves with 24VAC Solenoid 3-way

Product Number	Size	Description
101071331	80mm	Plastic 3"S 24VAC 3-way - Flanged
101071333	100mm	Plastic 4" Valve 24VAC 3-way - Flanged

RAF-P Plastic Threaded Valves with DC Latch Solenoid 3-way

Product Number	Size	Description
101071334	40mm	Plastic 1 1/2" Valve DC Latch 3-way - BSP
101071335	50mm	Plastic 2" Valve DC Latch 3-way - BSP
101071336	80mm	Plastic 3" Valve DC Latch 3-way - BSP
101071338	80mm	Plastic 3"S Valve DC Latch 3-way - BSP
101071340	100mm	Plastic 4" Valve DC Latch 3-way - BSP

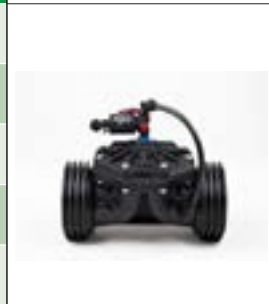

RAF-P Plastic Flanged Valves with DC Latch Solenoid 3-way

Product Number	Size	Description
101071339	80mm	Plastic 3"S DC Latch 3-way - Flanged
101071341	100mm	Plastic 4" Valve DC Latch 3-way - Flanged

Plastic valve supplied with 3-way Sagiv and 24VAC or DC Latch solenoid

RAF-P VALVES



RAF-P Plastic Threaded Pressure Reducing Valve with 3-way Sagiv

Product Number	Size	Description
101071342	40mm	Plastic 1 1/2" PRV 3-way W/Sagiv - BSP
101071343	50mm	Plastic 2" PRV 3-way W/Sagiv - BSP
101071344	80mm	Plastic 3" PRV 3-way W/Sagiv - BSP
101071346	80mm	Plastic 3"S PRV 3-way W/Sagiv - BSP
101071348	100mm	Plastic 4" PRV 3-way W/Sagiv - BSP



RAF-P Plastic Flanged Pressure Reducing Valve with 3-way Sagiv

Product Number	Size	Description
101071347	80mm	Plastic 3"S PRV 3-way W/Sagiv - Flanged
101071349	100mm	Plastic 4" PRV 3-way W/Sagiv -Flanged

RAF-P Plastic Threaded Pressure Reducing Valve with 3-way Sagiv + Shuttle Tee

Product Number	Size	Description
101071350	40mm	Plastic 1 1/2" PRV 3-way Sagiv + Shuttle Tee - BSP
101071351	50mm	Plastic 2" PRV BSP 3-way Sagiv + Shuttle Tee - BSP
101071352	80mm	Plastic 3" PRV BSP 3-way Sagiv + Shuttle Tee - BSP
101071354	80mm	Plastic 3"S PRV BSP 3-way Sagiv + Shuttle Tee - BSP
101071356	100mm	Plastic 4" PRV BSP 3-way Sagiv + Shuttle Tee - BSP



RAF-P Plastic Flanged Pressure Reducing Valve with 3-way Sagiv + Shuttle Tee

Product Number	Size	Description
101071355	80mm	Plastic 3"S PRV 3-way Sagiv + Shuttle Tee - Flanged
101071357	100mm	Plastic 4" PRV 3-way Sagiv + Shuttle Tee - Flanged

RAF PR 3-way Pressure Reducing pilot with standard Green Spring 0.4- 4.5 bar
ARAD Pilot available on request.

RAF-P VALVES



RAF-P Plastic Threaded Pressure Reducing Valve with Galit Hydraulic Relay

Product Number	Size	Description
101072610	40mm	Plastic 1 1/2" PRV 3-way W/Galit - BSP
101072611	50mm	Plastic 2" PRV 3-way W/Galit - BSP
101072612	80mm	Plastic 3" PRV 3-way W/Galit - BSP
101072614	80mm	Plastic 3"S PRV 3-way W/Galit - BSP
101072616	100mm	Plastic 4" PRV 3-way W/Galit - BSP



RAF-P Plastic Flanged Pressure Reducing Valve with Galit Hydraulic Relay

Product Number	Size	Description
101072613	80mm	Plastic 3"S PRV 3-way W/Galit - Flanged
101072617	100mm	Plastic 4" PRV 3-way W/Galit - Flanged

RAF PR 3-way Pressure Reducing pilot with standard Green Spring 0.4-4.5 bar

RAF-P Plastic Threaded Electric Pressure Reducing Valve with Sagiv 24VAC

Product Number	Size	Description
101072634	40mm	Plastic 1 1/2" Electric PRV 24VAC 3-way W/Sagiv - BSP
101072635	50mm	Plastic 2" Electric PRV 24VAC 3-way W/Sagiv - BSP
101072636	80mm	Plastic 3" Electric PRV 24VAC 3-way W/Sagiv - BSP
101072638	80mm	Plastic 3"S Electric PRV 24VAC 3-way W/Sagiv - BSP
101072640	100mm	Plastic 4" Electric PRV 24VAC 3-way W/Sagiv - BSP

RAF-P Plastic Flanged Electric Pressure Reducing Valve with Sagiv 24VAC

Product Number	Size	Description
101072639	80mm	Plastic 3"S Electric PRV 24VAC 3-way W/Sagiv - Flanged
101072641	100mm	Plastic 4" Electric PRV 24VAC 3-way W/Sagiv - Flanged

RAF PR 3-way Pressure Reducing Pilot with standard Green Spring 0.4-4.5 bar
ARAD Pilot available on request.

RAF-P VALVES



RAF-P Plastic Threaded Electric Pressure Reducing Valve with Sagiv DC Latch

Product Number	Size	Description
101072642	40mm	Plastic 1 1/2" Electric PRV DC Latch 3-way W/Sagiv - BSP
101072643	50mm	Plastic 2" Electric PRV DC Latch 3-way W/Sagiv - BSP
101072644	80mm	Plastic 3" Electric PRV DC Latch 3-way W/Sagiv - BSP
101072646	80mm	Plastic 3"S Electric PRV DC Latch 3-way W/Sagiv - BSP
101072648	100mm	Plastic 4" Electric PRV DC Latch 3-way W/Sagiv - BSP

RAF-P Plastic Flanged Electric Pressure Reducing Valve with Sagiv DC Latch

Product Number	Size	Description
101072647	80mm	Plastic 3"S Electric PRV DC Latch 3-way W/Sagiv - Flanged
101072649	100mm	Plastic 4" Electric PRV DC Latch 3-way W/Sagiv - Flanged

RAF PR 3-way Pressure Reducing pilot with standard Green Spring 0.4-4.5 bar

RAF-P Plastic Threaded Pressure Sustaining Valve with 3-way Sagiv

Product Number	Size	Description
101072618	40mm	Plastic 1 1/2" PSV 3-way W/Sagiv - BSP
101072619	50mm	Plastic 2" PSV 3-way W/Sagiv - BSP
101072620	80mm	Plastic 3" PSV 3-way W/Sagiv - BSP
101072622	80mm	Plastic 3"S PSV 3-way W/Sagiv - BSP
101072624	100mm	Plastic 4" PSV 3-way W/Sagiv - BSP

RAF-P Plastic Flanged Pressure Sustaining Valve with 3-way Sagiv

Product Number	Size	Description
101072623	80mm	Plastic 3"S PSV 3-way W/Sagiv - Flanged
101072625	100mm	Plastic 4" PSV 3-way W/Sagiv - Flanged

RAF PSR 3-way Pressure Sustaining Pilot with standard Green Spring 0.4-4.5 bar.
ARAD Pilot available on request.

RAF-P VALVES



RAF-P Plastic Flanged Electric Pressure Sustaining Valve with Sagiv 24VAC

Product Number	Size	Description
AUV010001	40mm	Plastic 1 1/2" Electric PSV 24VAC 3-way W/Sagiv - BSP
AUV010002	50mm	Plastic 2" Electric PSV 24VAC 3-way W/Sagiv - BSP
101074512	80mm	Plastic 3" Electric PSV 24VAC 3-way W/Sagiv - BSP
AUV010004	80mm	Plastic 3"S Electric PSV 24VAC 3-way W/Sagiv - BSP
AUV010005	100mm	Plastic 4" Electric PSV 24VAC 3-way W/Sagiv - BSP

RAF-P Plastic Flanged Electric Pressure Sustaining Valve with Sagiv 24VAC

Product Number	Size	Description
AUV010006	80mm	Plastic 3"S Electric PSV 24VAC 3-way W/Sagiv - Flanged
AUV010007	100mm	Plastic 4" Electric PSV 24VAC 3-way W/Sagiv- Flanged

RAF-P Plastic Threaded Electric Pressure Sustaining Valve with Sagiv DC Latch

Product Number	Size	Description
AUV010008	40mm	Plastic 1 1/2" Electric PSV DC Latch 3-way W/Sagiv - BSP
AUV010009	50mm	Plastic 2" Electric PSV DC Latch 3-way W/Sagiv - BSP
AUV010010	80mm	Plastic 3" Electric PSV DC Latch 3-way W/Sagiv - BSP
AUV010011	80mm	Plastic 3"S Electric PSV DC Latch 3-way W/Sagiv - BSP
AUV010012	100mm	Plastic 4" Electric PSV DC Latch 3-way W/Sagiv - BSP

RAF-P Plastic Flanged Electric Pressure Sustaining Valve with Sagiv DC Latch

Product Number	Size	Description
AUV010013	80mm	Plastic 3"S Electric PSV DC Latch 3-way W/Sagiv - Flanged
AUV010014	100mm	Plastic 4" Electric PSV DC Latch 3-way W/Sagiv - Flanged

RAF PSR 3-way Pressure Sustaining Pilot with standard Green Spring 0.4-4.5 bar.
ARAD Pilot available on request.

RAF-P VALVES



RAF-P Plastic Threaded Pressure Reducing and Sustaining Valve with 3-way Sagiv

Product Number	Size	Description
101072626	40mm	Plastic 1 1/2" PR+PS 3-way W/Sagiv - BSP
101072627	50mm	Plastic 2" PR+PS 3-way W/Sagiv - BSP
101072628	80mm	Plastic 3" PR+PS 3-way W/Sagiv - BSP
101072630	80mm	Plastic 3"S PR+PS 3-way W/Sagiv - BSP
101072632	100mm	Plastic 4" PR+PS 3-way W/Sagiv - BSP



RAF-P Plastic Flanged Pressure Reducing and Sustaining Valve with 3-way Sagiv

Product Number	Size	Description
101072631	80mm	PLASTIC 3"S PR+PS 3-way w/SAGIV - Flanged
101072633	100mm	PLASTIC 4" PR+PS 3-way w/SAGIV - Flanged



RAF PR 3-way Pressure Reducing Pilot and PSR 3-way Pressure Sustaining Pilot, both with standard Green Spring 0.4-4.5 bar.
ARAD Pilot available on request.

RAF Metal Valves



Basic RAF Valve

The valves are made of only three parts, each one is made of durable materials. The inner flow passages are streamlined and have a low friction coating. This provides quiet flow in both directions, low head-loss and minimal wear. Valves operate with a patented reinforced diaphragm, which eliminates the need for a metal spring. The special elastic design enables gradual and precise opening and closing of the valve. By eliminating the metal spring, the RAF is virtually maintenance free.

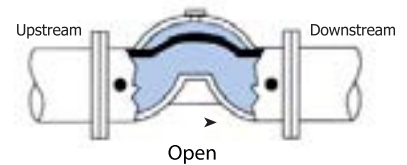
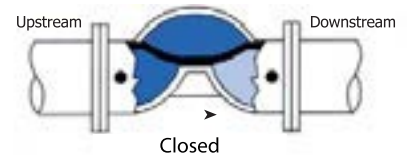

Construction

Standard Materials

- Body - Cast or Ductile Iron depending on size
- Cover - Cast Iron
- Washer - Plated Steel
- Diaphragm - Natural Rubber
- Bolts - Plated Steel
- Coating - Epoxy
- Nuts - Plated Steel

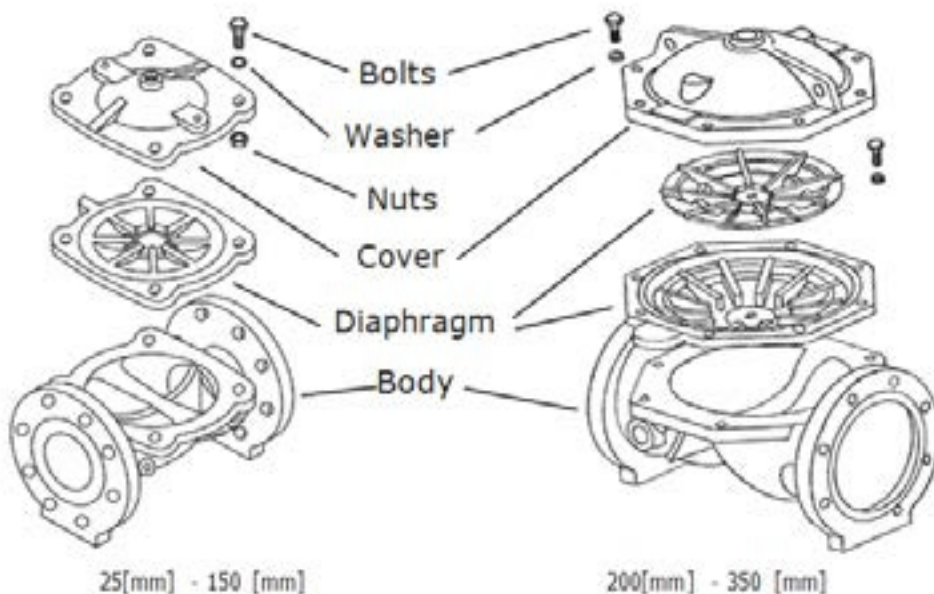

RAF IN-LINE METAL VALVES



Technical specifications

Threaded Valves

Valve Size		L	H	W	h	Weight	Flow @ $\Delta 0.1$ bar	Max Flow	Min Inlet Pressure	Control Chamber	Kv
mm	inch	mm	mm	mm	mm	kg	m ³ /h	m ³ /h	bar	L	(Fully Open)
25	1	156	70	94	21	1.5	11	20	0.8	0.07	35
40	1 1/2	159	80	96	29	2	13	25	0.8	0.07	40
50	2	190	100	125	38	3.5	21	45	0.7	0.08	65
80x65x80	3x 2 1/2 x3	244	127	138	50	5.5	35	70	0.7	0.16	110
80	3	290	138	200	50	11	47	90	0.6	0.3	150
100	4	346	220	230	60	16.5	89	150	0.4	0.8	280

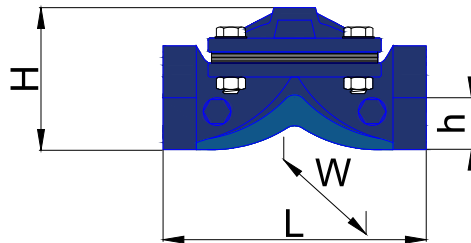

Flanged Valves

Valve Size		L	H	W	h	Weight	Flow @ $\Delta 0.1$ bar	Max Flow	Min Inlet Pressure	Control Chamber	Kv
mm	inch	mm	mm	mm	mm	kg	m ³ /h	m ³ /h	bar	L	(Fully Open)
50	2	190	159	165	76	8	21	45	0.7	0.08	65
80x65x80	3x 2 1/2 x3	216	192	200	92	11.5	35	70	0.7	0.16	110
80	3	283	200	200	100	15	47	90	0.6	0.3	150
100x80x100	4x3x4	283	222	222	111	20	47	90	0.6	0.3	150
100	4	305	220	230	115	18	89	150	0.4	0.8	280
150x100x100	6x4x6	325	243	285	143	35	89	150	0.4	0.8	280
150	6	406	295	300	142	36	120	300	0.4	1.6	380
200	8	470	383	354	160	57	215	500	0.4	3.5	680
250	10	635	430	464	197	111	411	900	0.3	7.6	1300
300	12	749	474	480	234	151	411	1000	0.3	7.6	1300
350	14	766	648	616	267	257	585	1300	0.3	25	1850
400	16	860	705	616	299	305	617	1500	0.3	25	1950

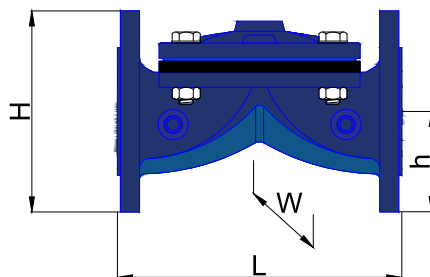

RAF IN-LINE METAL VALVES



Flow Chart

RAF Metal In-Line Valve Headloss

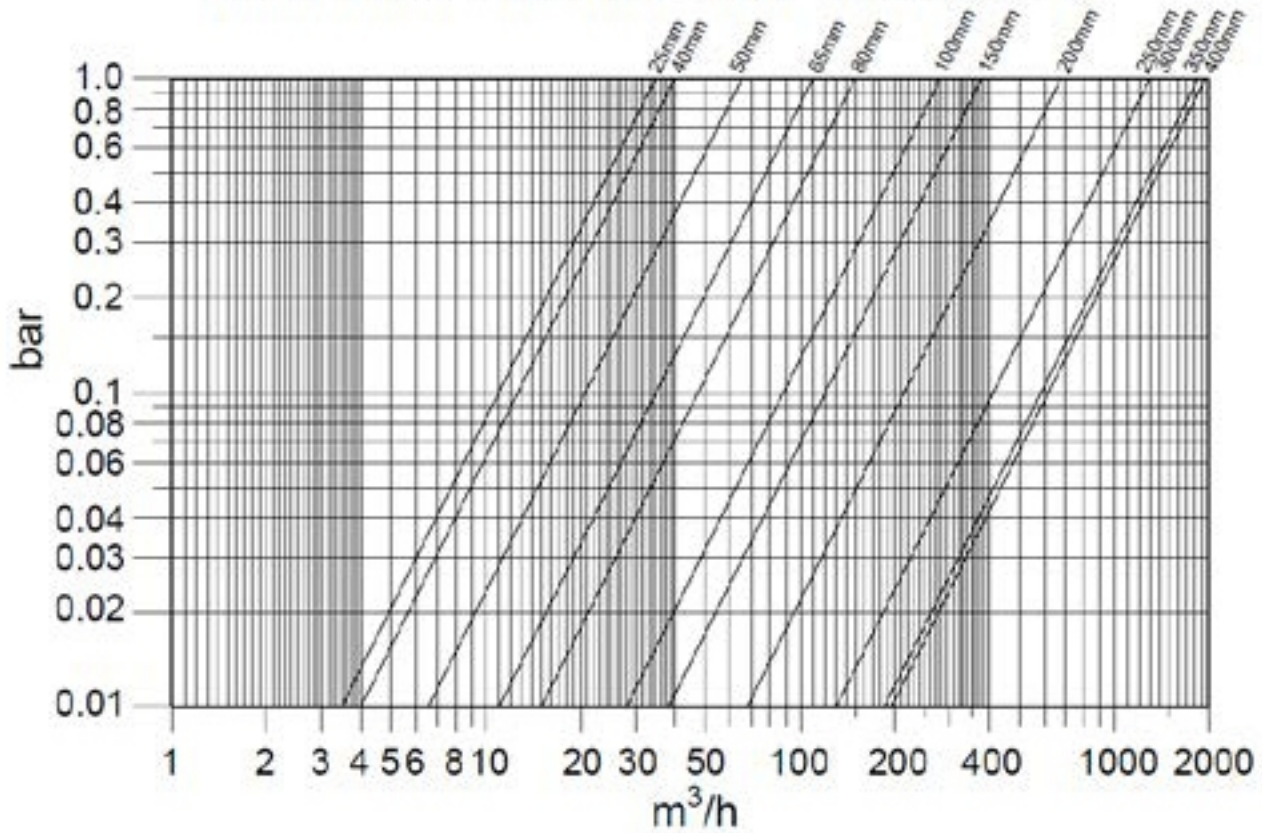

$$Q = Kv \sqrt{\Delta P}$$

$$\Delta P = (Q/Kv)^2$$

$$Q = m^3/h \quad \Delta P = \text{bar}$$

RAF ANGLE METAL VALVES



Technical specifications

Threaded Valves

Valve Size		L	H	W	h	Weight	Flow @ $\Delta 0.1$ bar	Max Flow	Min Inlet Pressure	Control Chamber	Kv
mm	inch	mm	mm	mm	mm	kg	m ³ /h	m ³ /h	bar	L	(Fully Open)
50	2	90	150	125	81	4.2	13	25	0.8	0.08	41
80x65x80	3x 2½x3	130	170	140	86	4.6	25	55	0.7	0.16	80
80	3	148	205	200	107	12	35	70	0.6	0.3	110
100	4	150	227	230	118	16	57	110	0.4	0.8	180

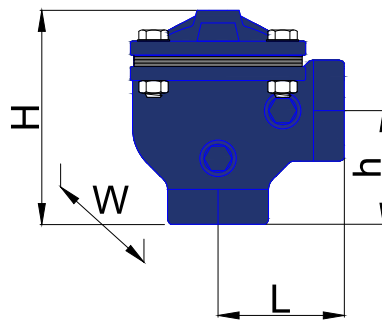

Flanged Valves

Valve Size		L	H	W	h	Weight	Flow @ $\Delta 0.1$ bar	Max Flow	Min Inlet Pressure	Control Chamber	Kv
mm	inch	mm	mm	mm	mm	kg	m ³ /h	m ³ /h	bar	L	(Fully Open)
50	2	112	159	165	77	8.1	13	25	0.8	0.08	41
80x65x80	3x 2½x3	130	215	200	115	11.7	25	55	0.7	0.16	80
80	3	154	210	200	115	19	35	70	0.6	0.3	110
100x80x100	4x3x4	155	225	220	110	19.5	35	70	0.6	0.3	110
100	4	177	230	230	113	26.5	57	110	0.4	0.8	180
150	6	218	315	300	148	49	85	200	0.4	1.6	270

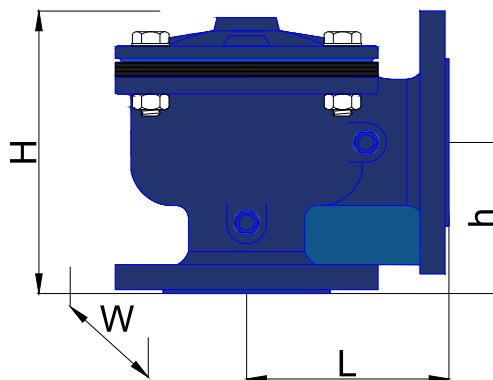

RAF ANGLE METAL VALVES



Flow Chart

RAF Metal Angle Valve Headloss

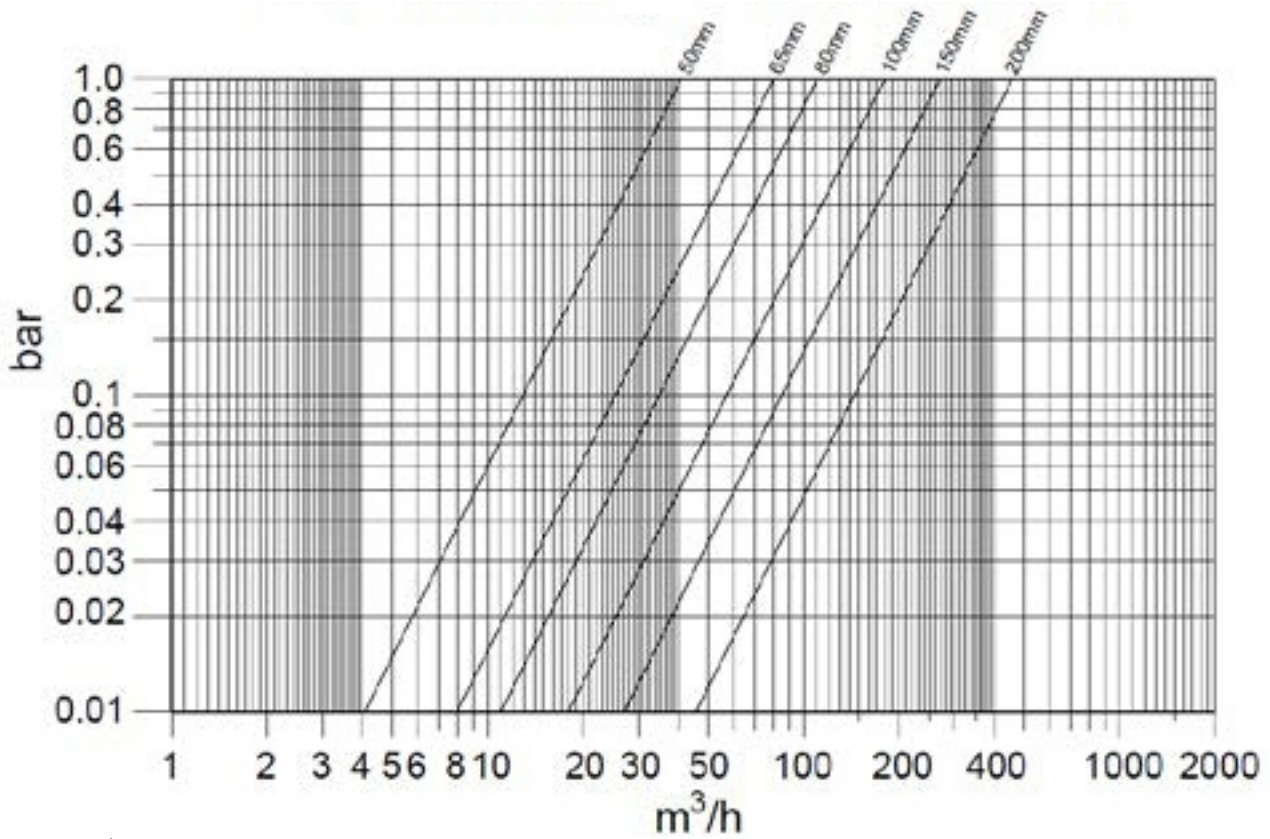

$$Q = K_v \sqrt{\Delta P}$$

$$\Delta P = (Q/K_v)^2$$

$$Q = \text{m}^3/\text{h} \quad \Delta P = \text{bar}$$

RAF METAL VALVES



RAF Metal Basic Threaded Inline Valves

Product Number	Size	Description
101011499	25mm	Metal 1" Basic Valve Inline - BSP
101011500	40mm	Metal 1½" Basic Valve Inline - BSP
101011498	50mm	Metal 2" Basic Valve Inline - BSP
101011503	80x65x80mm	Metal 3x 2½ x3" Basic Valve Inline - BSP
101011504	80mm	Metal 3" Basic Valve Inline - BSP



RAF Metal Basic Flanged Inline Valves

Product Number	Size	Description
101071795	50mm	Metal 2" Basic Valve Inline - Flanged
101071799	80x65x80mm	Metal 3x 2½ x3" Basic Valve Inline - Flanged
101071798	80mm	Metal 3" Basic Valve Inline - Flanged
101071801	100x80x100mm	Metal 4x3x4" Basic Valve Inline - Flanged
101071800	100mm	Metal 4" Basic Valve Inline - Flanged
101071803	150x100x150mm	Metal 6x4x6" Basic Valve Inline - Flanged
101071802	150mm	Metal 6" Basic Valve Inline - Flanged
101071804	200mm	Metal 8" Basic Valve Inline - Flanged
101071790	250mm	Metal 10" Basic Valve Inline - Flanged
101071791	300mm	Metal 12" Basic Valve Inline - Flanged
101071792	350mm	Metal 14" Basic Valve Inline - Flanged
101071794	400mm	Metal 16" Basic Valve Inline - Flanged



Basic Metal Valve, Pressure rating 16bar

RAF METAL VALVES



RAF Metal Basic Threaded Angle Valves

Product Number	Size	Description
101011525	50mm	Metal 2" Basic Valve Angle - BSP
101011528	80x65x80mm	Metal 3x 2½x3" Basic Valve Angle - BSP
101071783	80mm	Metal 3" Basic Valve Angle - BSP

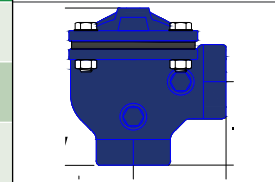

RAF Metal Basic Flanged Angle Valves

Product Number	Size	Description
101071785	80x65x80mm	Metal 3x 2½x3" Basic Valve Angle - Flanged
101071784	80mm	Metal 3" Basic Valve Angle - Flanged
101071787	100x80x100mm	Metal 4x3x4" Basic Valve Angle - Flanged
101071786	100mm	Metal 4" Basic Valve Angle - Flanged
101071788	150mm	Metal 6" Basic Valve Angle - Flanged



RAF METAL VALVES



RAF Metal Threaded Valves With Manual 3-Way Sagiv

Product Number	Size	Description
101072650	25mm	Metal 1" Manual Valve Inline - BSP + 3W Sagiv
101011605	40mm	Metal 1½" Manual Valve Inline - BSP + 3W Sagiv
101011606	50mm	Metal 2" Manual Valve Inline - BSP + 3W Sagiv
101011607	80x65x80mm	Metal 3x 2½x3" Manual Valve Inline - BSP + 3W Sagiv
101011576	80mm	Metal 3" Manual Valve Inline - BSP + 3W Sagiv

RAF Metal Flanged Valves With Manual 3-Way Sagiv

Product Number	Size	Description
101072651	50mm	Metal 2" Manual Valve Inline - Flanged + 3W Sagiv
101072652	80x65x80mm	Metal 3x 2½x3" Manual Valve Inline - Flanged + 3W Sagiv
101072653	80mm	Metal 3" Manual Valve Inline - Flanged + 3W Sagiv
101072654	100x80x100mm	Metal 4x3x4" Manual Valve Inline - Flanged + 3W Sagiv
101072655	100mm	Metal 4" Manual Valve Inline - Flanged + 3W Sagiv
101072656	150x100x150mm	Metal 6x4x6" Manual Valve Inline - Flanged + 3W Sagiv
101072657	150mm	Metal 6" Manual Valve Inline - Flanged + 3W Sagiv
101072671	200mm	Metal 8" Manual Valve Inline - Flanged + 3W Sagiv (PN16)
101072672	250mm	Metal 10" Manual Valve Inline - Flanged + 3W Sagiv (PN16)
101072673	300mm	Metal 12" Manual Valve Inline - Flanged + 3W Sagiv (PN16)



Metal manual control valve with 3 way Sagiv, pressure rating 10bar

RAF Metal Threaded Valves With Galit Hydraulic Relay

Product Number	Size	Description
AUV010015	25mm	Metal 1" Manual Valve Inline - BSP + Galit
AUV010199	40mm	Metal 1½" Manual Valve Inline - BSP + Galit
AUV010016	50mm	Metal 2" Manual Valve Inline - BSP + Galit
AUV010017	80x65x80mm	Metal 3x 2½x3" Manual Valve Inline - BSP + Galit
AUV010018	80mm	Metal 3" Manual Valve Inline - BSP + Galit



Metal control valve with Galit, pressure rating 10bar

RAF METAL VALVES



RAF Metal Flanged Valves With Galit Hydraulic Relay

Product Number	Size	Description
AUV010019	50mm	Metal 2" Manual Valve Inline - Flanged + Galit
AUV010020	80x65x80mm	Metal 3x 2½x3" Manual Valve Inline - Flanged + Galit
AUV010021	80mm	Metal 3" Manual Valve Inline - Flanged + Galit
AUV010022	100x80x100mm	Metal 4x3x4" Manual Valve Inline - Flanged + Galit
AUV010023	100mm	Metal 4" Manual Valve Inline - Flanged + Galit
AUV010024	150x100x150mm	Metal 6x4x6" Manual Valve Inline - Flanged + Galit
AUV010025	150mm	Metal 6" Manual Valve Inline - Flanged + Galit

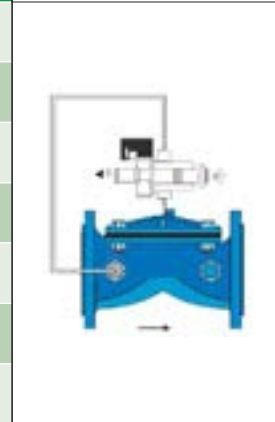

RAF Metal Threaded Angle Valves With Manual 3-Way Sagiv

Product Number	Size	Description
101011620	50mm	Metal 2" Manual Valve Angle - BSP + 3W Sagiv
101011621	80x65x80mm	Metal 3x 2½ x3" Manual Valve Angle - BSP + 3W Sagiv
101011623	80mm	Metal 3" Manual Valve Angle - BSP + 3W Sagiv

RAF Metal Flanged Angle Valves With Manual 3-Way Sagiv

Product Number	Size	Description
101072658	80x65x80mm	Metal 3x 2½x3" Manual Valve Angle - Flanged + 3W Sagiv
101072659	80mm	Metal 3" Manual Valve Angle - Flanged + 3W Sagiv
101072660	100mm	Metal 4" Manual Valve Angle - Flanged + 3W Sagiv
AUV010026	150mm	Metal 6" Manual Valve Angle - Flanged + 3W Sagiv

RAF Metal Threaded Angle Valves With Galit Hydraulic Relay

Product Number	Size	Description
AUV010027	50mm	Metal 2" Manual Valve Angle - BSP + Galit Relay
AUV010028	80x65x80mm	Metal 3x 2½x3" Manual Valve Angle - BSP + Galit Relay
AUV010029	80mm	Metal 3" Manual Valve Angle - BSP + Galit Relay

RAF METAL VALVES



RAF Metal Flanged Angle Valves With Galit Hydraulic Relay

Product Number	Size	Description
AUV010030	80x65x80mm	Metal 3x 2½x3" Manual Valve Angle - Flanged + Galit Relay
AUV010031	80mm	Metal 3" Manual Valve Angle - Flanged + Galit Relay
AUV010032	100mm	Metal 4" Manual Valve Angle - Flanged + Galit Relay
AUV010033	150mm	Metal 6" Manual Valve Angle - Flanged + Galit Relay

Metal control valve with Galit, pressure rating 10bar

RAF METAL VALVES



RAF Metal Threaded Valves With 24VAC Solenoid and 3-Way Sagiv

Product Number	Size	Description
101072097	25mm	Metal 1" Electric Valve Inline - BSP 24VAC + 3W Sagiv
101012111	40mm	Metal 1½" Electric Valve Inline - BSP 24VAC + 3W Sagiv
101012112	50mm	Metal 2" Electric Valve Inline - BSP 24VAC + 3W Sagiv
101010095	80x65x80mm	Metal 3x 2½x3" Electric Valve Inline - BSP 24VAC + 3W Sagiv
101012114	80mm	Metal 3" Electric Valve Inline - BSP 24VAC + 3W Sagiv



RAF Metal Flanged Valves With 24VAC Solenoid and 3-Way Sagiv

Product Number	Size	Description
101072098	50mm	Metal 2" Electric Valve Inline - Flanged 24VAC + 3W Sagiv
101072099	80x65x80mm	Metal 3x2½x3" Electric Valve Inline - Flanged 24VAC + 3W Sagiv
101072100	80mm	Metal 3" Electric Valve Inline - Flanged 24VAC + 3W Sagiv
101072101	100x80x100mm	Metal 4x3x4" Electric Valve Inline - Flanged 24VAC + 3W Sagiv
101072102	100mm	Metal 4" Electric Valve Inline - Flanged 24VAC + 3W Sagiv
101072103	150x100x150mm	Metal 6x4x6" Electric Valve Inline - Flanged 24VAC + 3W Sagiv
101072104	150mm	Metal 6" Electric Valve Inline - Flanged 24VAC + 3W Sagiv
101072105	200mm	Metal 8" Electric Valve Inline - Flanged 24VAC + 3W Sagiv
101072106	250mm	Metal 10" Electric Valve Inline - Flanged 24VAC + 3W Sagiv
101072107	300mm	Metal 12" Electric Valve Inline - Flanged 24VAC + 3W Sagiv



Valves up to 100mm use Baccara G75 solenoid with plastic Tefen fittings and 8mm PE tubing. 150mm valves use Gemsol solenoid with Tefen plastic fittings. Pressure rating = 10 bar
 Valves 200mm and above use Gemsol solenoid and 10mm Nylon tubing with brass fittings. Pressure rating = 16 bar.

RAF METAL VALVES



RAF Metal Threaded Valves With DC Latching Solenoid and 3-Way Sagiv

Product Number	Size	Description
101072112	25mm	Metal 1" Electric Valve Inline - BSP DC Latch + 3W Sagiv
101072113	40mm	Metal ½" Electric Valve Inline - BSP DC Latch + 3W Sagiv
101012129	50mm	Metal 2" Electric Valve Inline - BSP DC Latch + 3W Sagiv
101072114	80x65x80mm	Metal 3x 2½x 3" Electric Valve Inline - BSP DC Latch + 3W Sagiv
101072115	80mm	Metal 3" Electric Valve Inline - BSP DC Latch + 3W Sagiv



RAF Metal Flanged Valves With DC Latching Solenoid and 3-Way Sagiv

Product Number	Size	Description
101072116	50mm	Metal 2" Electric Valve Inline - Flanged DC Latch + 3W Sagiv
101072117	80x65x80mm	Metal 3x 2½x3" Electric Valve Inline - Flanged DC Latch + 3W Sagiv
101072118	80mm	Metal 3" Electric Valve Inline - Flanged DC Latch + 3W Sagiv
101072119	100x80x100mm	Metal 4x3x4" Electric Valve Inline - Flanged DC Latch + 3W Sagiv
101072120	100mm	Metal 4" Electric Valve Inline - Flanged DC Latch + 3W Sagiv
101072121	150x100x150mm	Metal 6x4x6" Electric Valve Inline - Flanged DC Latch + 3W Sagiv
101072122	150mm	Metal 6" Electric Valve Inline - Flanged DC Latch + 3W Sagiv
101072123	200mm	Metal 8" Electric Valve Inline - Flanged DC Latch + 3W Sagiv
101072124	250mm	Metal 10" Electric Valve Inline - Flanged DC Latch + 3W Sagiv
101072125	300mm	Metal 12" Electric Valve Inline - Flanged DC Latch + 3W Sagiv



Valves up to 150mm use Baccara G75-A3P latching solenoid with plastic Tefen fittings and 8mm PE tubing.
 Pressure rating = 10 bar
 Valves 200mm and above use Gemsol -A3P latching solenoid and 10mm Nylon tubing with brass fittings.
 Pressure rating = 16 bar.

RAF METAL VALVES



RAF Metal Threaded Angle Valves With 24VAC Solenoid and 3-Way Sagiv

Product Number	Size	Description
101072108	80x65x80mm	Metal 3x 2½x3" Electric Valve Angle - BSP 24VAC + 3W Sagiv

RAF Metal Flanged Angle Valves With 24VAC Solenoid and 3-Way Sagiv

Product Number	Size	Description
101072109	80x65x80mm	Metal 3x 2½x3" Electric Valve Angle - Flanged 24VAC + 3W Sagiv
101072110	80mm	Metal 3" Electric Valve Angle - Flanged 24VAC + 3W Sagiv
AUV010034	100x80x100mm	Metal 4x3x4" Electric Valve Angle - Flanged 24VAC + 3W Sagiv
101072111	100mm	Metal 4" Electric Valve Angle - Flanged 24VAC + 3W Sagiv
AUV010035	150mm	Metal 6" Electric Valve Angle - Flanged 24VAC + 3W Sagiv

RAF Metal Threaded Angle Valves With DC Latch Solenoid and 3-Way Sagiv

Product Number	Size	Description
101072126	80mm	Metal 3" Electric Valve Angle - BSP DC Latch + 3W Sagiv

RAF Metal Flanged Angle Valves With DC Latch Solenoid and 3-Way Sagiv

Product Number	Size	Description
101072127	80x65x80mm	Metal 3x 2½x3" Electric Valve Angle - Flanged DC Latch + 3W Sagiv
101072128	80mm	Metal 3" Electric Valve Angle - Flanged DC Latch + 3W Sagiv
AUV010036	100x80x100mm	Metal 4x3x4" Electric Valve Angle - Flanged DC Latch + 3W Sagiv
101072129	100mm	Metal 4" Electric Valve Angle - Flanged DC Latch + 3W Sagiv
AUV010037	150mm	Metal 6" Electric Valve Angle - Flanged DC Latch + 3W Sagiv

Valves up to 100mm use Baccara DC Latch Solenoid with plastic Tefen fittings and 8mm PE tubing.
150mm valves use Gemsol solenoid with Tefen plastic fittings. Pressure rating = 10 bar

RAF METAL VALVES



RAF Metal Threaded 3-Way Pressure Reducing Valve With 3-Way Sagiv

Product Number	Size	Description
101072680	25mm	Metal 1" 3W Pressure Reducing Valve Inline - BSP + Sagiv
101072681	40mm	Metal 1½" 3W Pressure Reducing Valve Inline - BSP + Sagiv
101072682	50mm	Metal 2" 3W Pressure Reducing Valve Inline - BSP + Sagiv
101072683	80x65x80mm	Metal 3x 2½x3" 3W Pressure Reducing Valve Inline - BSP + Sagiv
101072684	80mm	Metal 3" 3W Pressure Reducing Valve Inline - BSP + Sagiv



RAF Metal Flanged 3-Way Pressure Reducing Valve With 3-Way Sagiv

Product Number	Size	Description
101072685	50mm	Metal 2" 3W Pressure Reducing Valve Inline - Flanged + Sagiv
101072686	80x65x80mm	Metal 3x 2½x3" 3W Pressure Reducing Valve Inline - Flanged + Sagiv
101072687	80mm	Metal 3" 3W Pressure Reducing Valve Inline - Flanged + Sagiv
101072688	100x80x100mm	Metal 4x3x4" 3W Pressure Reducing Valve Inline - Flanged + Sagiv
101072689	100mm	Metal 4" 3W Pressure Reducing Valve Inline - Flanged + Sagiv
101072690	150x100x150mm	Metal 6x4x6" 3W Pressure Reducing Valve Inline - Flanged + Sagiv
101072691	150mm	Metal 6" 3W Pressure Reducing Valve Inline - Flanged + Sagiv
101072693	200mm	Metal 8" 3W Pressure Reducing Valve Brass Pilot Inline - Flanged + Sagiv
101072694	250mm	Metal 10" 3W Pressure Reducing Valve Brass Pilot Inline - Flanged + Sagiv
101072695	300mm	Metal 12" 3W Pressure Reducing Valve Brass Pilot Inline - Flanged + Sagiv



RAF Metal Threaded 3-Way Pressure Reducing Valve With Galit Hydraulic Relay

Product Number	Size	Description
101072701	40mm	Metal 1½" 3W Pressure Reducing Valve Inline - BSP + Galit
101072702	50mm	Metal 2" 3W Pressure Reducing Valve Inline - BSP + Galit
101072703	80x65x80mm	Metal 3x 2½x3" 3W Pressure Reducing Valve Inline - BSP + Galit
101072704	80mm	Metal 3" 3W Pressure Reducing Valve Inline - BSP + Galit

Valves up to 150mm use a RAF PR 3-way Pressure Reducing pilot with standard Green Spring 0.4-4.5bar Pressure rating = 10 bar

Valves 200mm and above use a Brass 683 3-way pressure Reducing pilot with standard Yellow Spring 2-16 bar Pressure rating = 16 bar

ARAD Pilot available on request for valves up to 150mm

RAF METAL VALVES



RAF Metal Flanged 3-Way Pressure Reducing Valve With Galit Hydraulic Relay

Product Number	Size	Description
101072705	50mm	Metal 2" 3W Pressure Reducing Valve Inline - Flanged + Galit
101072706	80x65x80mm	Metal 3x 2½x3" 3W Pressure Reducing Valve Inline - Flanged + Galit
101072707	80mm	Metal 3" 3W Pressure Reducing Valve Inline - Flanged + Galit
101072708	100x80x100mm	Metal 4x3x4" Pressure Reducing Valve Inline - Flanged + Galit
101072709	100mm	Metal 4" 3W Pressure Reducing Valve Inline - Flanged + Galit
101072710	150x100x150mm	Metal 6x4x6" 3W Pressure Reducing Valve Inline - Flanged + Galit
101072711	150mm	Metal 6" 3W Pressure Reducing Valve Inline - Flanged + Galit



RAF Metal Threaded 3-Way Pressure Reducing Valve With 3-Way Sagiv and Shuttle Tee

Product Number	Size	Description
101072723	40mm	Metal 1½" 3W Pressure Reducing Valve Inline - BSP + Sagiv & Shuttle Tee
101072724	50mm	Metal 2" 3W Pressure Reducing Valve Inline - BSP + Sagiv & Shuttle Tee
101072725	80x65x80mm	Metal 3x 2½x3" 3W Pressure Reducing Valve Inline - BSP + Sagiv & Shuttle Tee
AUV010101	80mm	Metal 3" 3W Pressure Reducing Valve Inline - BSP + Sagiv & Shuttle Tee

RAF Metal Flanged 3-Way Pressure Reducing Valve With 3-Way Sagiv and Shuttle Tee

Product Number	Size	Description
101072726	50mm	Metal 2" 3W Pressure Reducing Valve Inline - Flanged + Sagiv & Shuttle Tee
101072727	80x65x80mm	Metal 3x 2½x3" 3W Pressure Reducing Valve Inline - Flanged + Sagiv & Shuttle Tee
101072728	80mm	Metal 3" 3W Pressure Reducing Valve Inline - Flanged + Sagiv & Shuttle Tee
101072729	100x80x100mm	Metal 4x3x4" 3W Pressure Reducing Valve Inline - Flanged + Sagiv & Shuttle Tee
101072730	100mm	Metal 4" 3W Pressure Reducing Valve Inline - Flanged + Sagiv & Shuttle Tee
101072731	150x100x150mm	Metal 6x4x6" 3W Pressure Reducing Valve Inline - Flanged + Sagiv & Shuttle Tee
101072732	150mm	Metal 6" 3W Pressure Reducing Valve Inline - Flanged + Sagiv & Shuttle Tee

Valves up to 150mm use a RAF PR 3-way Pressure Reducing pilot with standard Green Spring 0.4-4.5bar
 Pressure rating = 10 bar
 ARAD Pilot available on request for valves up to 150mm

RAF METAL VALVES



RAF Metal Threaded Angle 3-Way Pressure Reducing Valve With 3-Way Sagiv

Product Number	Size	Description
101072696	50mm	Metal 2" 3W Pressure Reducing Valve Angle - BSP + Sagiv
AUV010039	80x65x80mm	Metal 3x 2½x3" 3W Pressure Reducing Valve Angle - BSP + Sagiv
AUV010038	80mm	Metal 3" 3W Pressure Reducing Valve Angle - BSP + Sagiv

RAF Metal Flanged Angle 3-Way Pressure Reducing Valve With 3-Way Sagiv

Product Number	Size	Description
101072697	80x65x80mm	Metal 3x 2½x3" 3W Pressure Reducing Valve Angle - Flanged + Sagiv
101072698	80mm	Metal 3" 3W Pressure Reducing Valve Angle - Flanged + Sagiv
101072699	100mm	Metal 4" 3W Pressure Reducing Valve Angle - Flanged + Sagiv

RAF Metal Threaded Angle 3-Way Pressure Reducing Valve With Galit Hydraulic Relay

Product Number	Size	Description
101072716	50mm	Metal 2" 3W Pressure Reducing Valve Angle - BSP + Galit
101072717	80x65x80mm	Metal 3x 2½x3" 3W Pressure Reducing Valve Angle - BSP + Galit
101072718	80mm	Metal 3" 3W Pressure Reducing Valve Angle - BSP + Galit

RAF Metal Flanged Angle 3-Way Pressure Reducing Valve With Galit Hydraulic Relay

Product Number	Size	Description
101072719	80x65x80mm	Metal 3x 2½x3" 3W Pressure Reducing Valve Angle - Flanged + Galit
101072720	80mm	Metal 3" 3W Pressure Reducing Valve Angle - Flanged + Galit
101072721	100mm	Metal 4" 3W Pressure Reducing Valve Angle - Flanged + Galit

RAF Metal Threaded Angle 3-Way Pressure Reducing Valve With 3-Way Sagiv and Shuttle Tee

Product Number	Size	Description
101072737	50mm	Metal 2" 3W Pressure Reducing Valve Angle - BSP + Sagiv & Shuttle Tee
101072738	80x65x80mm	Metal 3x 2½x3" 3W Pressure Reducing Valve Angle - BSP + Sagiv & Shuttle Tee
101072739	80mm	Metal 3" 3W Pressure Reducing Valve Angle - BSP + Sagiv & Shuttle Tee

Valves up to 150mm use a RAF PR 3-way Pressure Reducing pilot with standard Green Spring 0.4-4.5bar
 Pressure rating = 10 bar
 ARAD Pilot available on request for valves up to 150mm

RAF METAL VALVES



RAF Metal Flanged Angle 3-Way Pressure Reducing Valve With 3-Way Sagiv and Shuttle Tee

Product Number	Size	Description
101072740	80x65x80mm	Metal 3x 2½x3" 3W Pressure Reducing Valve Angle - Flanged + Sagiv & Shuttle Tee
101072741	80mm	Metal 3" 3W Pressure Reducing Valve Angle - Flanged + Sagiv & Shuttle Tee
101072742	100mm	Metal 4" 3W Pressure Reducing Valve Angle - Flanged + Sagiv & Shuttle Tee

ARAD Pilot available on request for valves up to 100m

RAF METAL VALVES



RAF Metal Threaded 3-Way Pressure Sustaining Valve With 3-Way Sagiv

Product Number	Size	Description
101072370	25mm	Metal 1" 3W Pressure Sustaining Valve Inline - BSP + Sagiv
101012072	40mm	Metal 1½" 3W Pressure Sustaining Valve Inline - BSP + Sagiv
101012056	50mm	Metal 2" 3W Pressure Sustaining Valve Inline - BSP + Sagiv
101012057	80x65x80mm	Metal 3x 2½x3" 3W Pressure Sustaining Valve Inline - BSP + Sagiv
101012059	80mm	Metal 3" 3W Pressure Sustaining Valve Inline - BSP + Sagiv



RAF Metal Flanged 3-Way Pressure Sustaining Valve With 3-Way Sagiv

Product Number	Size	Description
101072371	50mm	Metal 2" 3W Pressure Sustaining Valve Inline - Flanged + Sagiv
101072372	80x65x80mm	Metal 3x 2½x3" 3W Pressure Sustaining Valve Inline - Flanged + Sagiv
101072373	80mm	Metal 3" 3W Pressure Sustaining Valve Inline - Flanged + Sagiv
AUV010040	100x80x100mm	Metal 4x3x4" 3W Pressure Sustaining Valve Inline - Flanged + Sagiv
101072374	100mm	Metal 4" 3W Pressure Sustaining Valve Inline - Flanged + Sagiv
101072375	150x100x150mm	Metal 6x4x6" 3W Pressure Sustaining Valve Inline - Flanged + Sagiv
101072376	150mm	Metal 6" 3W Pressure Sustaining Valve Inline - Flanged + Sagiv
101072378	200mm	Metal 8" 3W Pressure Sustaining Valve Brass Pilot Inline - Flanged + Sagiv
101072379	250mm	Metal 10" 3W Pressure Sustaining Valve Brass Pilot Inline - Flanged + Sagiv
101072380	300mm	Metal 12" 3W Pressure Sustaining Valve Brass Pilot Inline - Flanged + Sagiv



Valves up to 150mm use a RAF PSR 3-way Pressure Sustaining pilot with standard Green Spring 0.4-4.5bar
Pressure rating = 10 bar

Valves 200mm and above use a Brass 6835 3-way pressure Sustaining pilot with standard Yellow Spring 2-16 bar
Pressure rating = 16 bar

ARAD Pilot available on request for valves up to 150mm

RAF METAL VALVES



RAF Metal Threaded Angle 3-Way Pressure Sustaining Valve With 3-Way Sagiv

Product Number	Size	Description
101034527	50mm	Metal 2" 3W Pressure Sustaining Valve Angle - BSP + Sagiv
101072381	80x65x80mm	Metal 3x 2½x3" 3W Pressure Sustaining Valve Angle - BSP + Sagiv
101072382	80mm	Metal 3" 3W Pressure Sustaining Valve Angle - BSP + Sagiv

RAF Metal Flanged Angle 3-Way Pressure Sustaining Valve With 3-Way Sagiv

Product Number	Size	Description
101072383	80x65x80mm	Metal 3x 2½x3" 3W Pressure Sustaining Valve Angle - Flanged + Sagiv
101072384	80mm	Metal 3" 3W Pressure Sustaining Valve Angle - Flanged + Sagiv
101072385	100mm	Metal 4" 3W Pressure Sustaining Valve Angle - Flanged + Sagiv

RAF Metal Threaded 3-Way Pressure Reducing and Sustaining Valve With 3-Way Sagiv

Product Number	Size	Description
101072386	25mm	Metal 1" 3W Pressure Reducing & Sustaining Valve Inline - BSP + Sagiv
101072387	40mm	Metal 1½" 3W Pressure Reducing & Sustaining Valve Inline - BSP + Sagiv
101072388	50mm	Metal 2" 3W Pressure Reducing & Sustaining Valve Inline - BSP + Sagiv
101072389	80x65x80mm	Metal 3x 2½x3" 3W Pressure Reducing & Sustaining Valve Inline - BSP + Sagiv
101072390	80mm	Metal 3" 3W Pressure Reducing & Sustaining Valve Inline - BSP + Sagiv



RAF Metal Flanged 3-Way Pressure Reducing and Sustaining Valve With 3-Way Sagiv

Product Number	Size	Description
101072391	50mm	Metal 2" 3W Pressure Reducing & Sustaining Valve Inline - Flanged + Sagiv
101072392	80x65x80mm	Metal 3x 2½x3" 3W Pressure Reducing & Sustaining Valve Inline - Flanged + Sagiv
101072393	80mm	Metal 3" 3W Pressure Reducing & Sustaining Valve Inline - Flanged + Sagiv
101072394	100x80x100mm	Metal 4x3x4" 3W Pressure Reducing & Sustaining Valve Inline - Flanged + Sagiv
101072395	100mm	Metal 4" 3W Pressure Reducing & Sustaining Valve Inline - Flanged + Sagiv
101072396	150x100x150mm	Metal 6x4x6" 3W Pressure Reducing & Sustaining Valve Inline - Flanged + Sagiv
101072397	150mm	Metal 6" 3W Pressure Reducing & Sustaining Valve Inline - Flanged + Sagiv
101072399	200mm	Metal 8" 3W Pressure Reducing & Sustaining Valve Brass Pilot Inline - Flanged + Sagiv
101072400	250mm	Metal 10" 3W Pressure Reducing & Sustaining Valve Brass Pilot Inline - Flanged + Sagiv
101072401	300mm	Metal 12" 3W Pressure Reducing & Sustaining Valve Brass Pilot Inline - Flanged + Sagiv



RAF METAL VALVES



RAF Metal Threaded Angle 3-Way Pressure Reducing and Sustaining Valve With 3-Way Sagiv

Product Number	Size	Description
101072402	50mm	Metal 2" 3W Pressure Reducing & Sustaining Valve Angle - BSP + Sagiv
101072403	80x65x80mm	Metal 3x 2½x3" 3W Pressure Reducing & Sustaining Valve Angle - BSP + Sagiv
101072404	80mm	Metal 3" 3W Pressure Reducing & Sustaining Valve Angle - BSP + Sagiv

RAF Metal Flanged Angle 3-Way Pressure Reducing and Sustaining Valve With 3-Way Sagiv

Product Number	Size	Description
101072405	80x65x80mm	Metal 3x 2½x3" 3W Pressure Reducing & Sustaining Valve Angle - Flanged + Sagiv
101072406	80mm	Metal 3" 3W Pressure Reducing & Sustaining Valve Angle - Flanged + Sagiv
101072407	100mm	Metal 4" 3W Pressure Reducing & Sustaining Valve Angle - Flanged + Sagiv

RAF PR 3-way Pressure Reducing Pilot and PSR 3-way Pressure Sustaining Pilot, both with standard Green Spring 0.4-4.5 bar.
ARAD Pilot available on request.

RAF METAL VALVES



RAF Metal Threaded Electric 3-Way Pressure Reducing Valve With 24VAC Solenoid and 3-Way Sagiv

Product Number	Size	Description
101072134	25mm	Metal 1" Electric 3W Pressure Reducing Valve Inline - BSP 24VAC + 3W Sagiv
101013583	40mm	Metal 1½" Electric 3W Pressure Reducing Valve Inline - BSP 24VAC + 3W Sagiv
101013584	50mm	Metal 2" Electric 3W Pressure Reducing Valve Inline - BSP 24VAC + 3W Sagiv
101013585	80x65x80mm	Metal 3x 2½x3" Electric 3W Pressure Reducing Valve Inline - BSP 24VAC + 3W Sagiv
101013588	80mm	Metal 3" Electric 3W Pressure Reducing Valve Inline - BSP 24VAC + 3W Sagiv



RAF Metal Flanged Electric 3-Way Pressure Reducing Valve With 24VAC Solenoid and 3-Way Sagiv

Product Number	Size	Description
101072137	50mm	Metal 2" Electric 3W Pressure Reducing Valve Inline - Flanged 24VAC + 3W Sagiv
101072159	80x65x80mm	Metal 3x 2½x3" Electric 3W Pressure Reducing Valve Inline - Flanged 24VAC + 3W Sagiv
101072160	80mm	Metal 3" Electric 3W Pressure Reducing Valve Inline - Flanged 24VAC + 3W Sagiv
101072161	100x80x100mm	Metal 4x3x4" Electric 3W Pressure Reducing Valve Inline - Flanged 24VAC + 3W Sagiv
101072162	100mm	Metal 4" Electric 3W Pressure Reducing Valve Inline - Flanged 24VAC + 3W Sagiv
101072163	150x100x150mm	Metal 6x4x6" Electric 3W Pressure Reducing Valve Inline - Flanged 24VAC + 3W Sagiv
101072164	150mm	Metal 6" Electric 3W Pressure Reducing Valve Inline - Flanged 24VAC + 3W Sagiv
101072166	200mm	Metal 8" Electric 3W Pressure Reducing Valve Inline - Flanged 24VAC + 3W Sagiv
101072167	250mm	Metal 10" Electric 3W Pressure Reducing Valve Inline - Flanged 24VAC + 3W Sagiv
101072168	300mm	Metal 12" Electric 3W Pressure Reducing Valve Inline - Flanged 24VAC + 3W Sagiv



Valves up to 150mm use a RAF PR 3-way Pressure Reducing pilot with standard Green Spring 0.4-4.5bar and Baccara G75 solenoid Pressure rating = 10 bar

Valves 200mm and above use a Brass 683 3-way pressure Reducing pilot with standard Yellow Spring 2.0-16.0 bar and a Gemsol solenoid Pressure rating = 16 bar

ARAD Pilot available on request for valves up to 150mm

RAF METAL VALVES



RAF Metal Threaded Electric 3-Way Pressure Reducing Valve With DC Latching Solenoid and 3-Way Sagiv

Product Number	Size	Description
101072173	25mm	Metal 1" Electric 3W Pressure Reducing Valve Inline - BSP DC Latch + 3W Sagiv
101072174	40mm	Metal 1½" Electric 3W Pressure Reducing Valve Inline - BSP DC Latch + 3W Sagiv
101013594	50mm	Metal 2" Electric 3W Pressure Reducing Valve Inline - BSP DC Latch + 3W Sagiv
101072175	80x65x80mm	Metal 3x 2½x3" Electric 3W Pressure Reducing Valve Inline - BSP DC Latch + 3W Sagiv
101072176	80mm	Metal 3" Electric 3W Pressure Reducing Valve Inline - BSP DC Latch + 3W Sagiv



RAF Metal Flanged Electric 3-Way Pressure Reducing Valve With DC Latching Solenoid and 3-Way Sagiv

Product Number	Size	Description
101072177	50mm	Metal 2" Electric 3W Pressure Reducing Valve Inline - Flanged DC Latch + 3W Sagiv
101072178	80x65x80mm	Metal 3x 2½x3" Electric 3W Pressure Reducing Valve Inline - Flanged DC Latch + 3W Sagiv
101072179	80mm	Metal 3" Electric 3W Pressure Reducing Valve Inline - Flanged DC Latch + 3W Sagiv
101072180	100x80x100mm	Metal 4x3x4" Electric 3W Pressure Reducing Valve Inline - Flanged DC Latch + 3W Sagiv
101072181	100mm	Metal 4" Electric 3W Pressure Reducing Valve Inline - Flanged DC Latch + 3W Sagiv
101072182	150x100x150mm	Metal 6x4x6" Electric 3W Pressure Reducing Valve Inline - Flanged DC Latch + 3W Sagiv
101072183	150mm	Metal 6" Electric 3W Pressure Reducing Valve Inline - Flanged DC Latch + 3W Sagiv
101072185	200mm	Metal 8" Electric 3W Pressure Reducing Valve Inline - Flanged DC Latch + 3W Sagiv
101072186	250mm	Metal 10" Electric 3W Pressure Reducing Valve Inline - Flanged DC Latch + 3W Sagiv
101072187	300mm	Metal 12" Electric 3W Pressure Reducing Valve Inline - Flanged DC Latch + 3W Sagiv



Valves up to 150mm use a RAF PR 3-way Pressure Reducing pilot with standard Green Spring 0.4-4.5bar and Baccara G75 solenoid Pressure rating = 10 bar

Valves 200mm and above use a Brass 683 3-way pressure Reducing pilot with standard Yellow Spring 2.0-16.0 bar and a Gemsol solenoid Pressure rating = 16 bar

ARAD Pilot available on request for valves up to 150mm

RAF METAL VALVES



RAF Metal Threaded Angle Electric 3-Way Pressure Reducing Valve With 24VAC Solenoid and 3-Way Sagiv

Product Number	Size	Description
101013589	50mm	Metal 2" Electric 3W Pressure Reducing Valve Angle - BSP 24VAC + 3W Sagiv
101013590	80x65x80mm	Metal 3x 2½x3" Electric 3W Pressure Reducing Valve Angle - BSP 24VAC + 3W Sagiv
101072169	80mm	Metal 3" Electric 3W Pressure Reducing Valve Angle - BSP 24VAC + 3W Sagiv

RAF Metal Flanged Angle Electric 3-Way Pressure Reducing Valve With 24VAC Solenoid and 3-Way Sagiv

Product Number	Size	Description
101072170	80x65x80mm	Metal 3x 2½x3" Electric 3W Pressure Reducing Valve Angle - Flanged 24VAC + 3W Sagiv
101072171	80mm	Metal 3" Electric 3W Pressure Reducing Valve Angle - Flanged 24VAC + 3W Sagiv
101072172	100mm	Metal 4" Electric 3W Pressure Reducing Valve Angle - Flanged 24VAC + 3W Sagiv

RAF Metal Threaded Angle Electric 3-Way Pressure Reducing Valve With DC Latching Solenoid and 3-Way Sagiv

Product Number	Size	Description
101013591	50mm	Metal 2" Electric 3W Pressure Reducing Valve Angle - BSP DC Latch + 3W Sagiv
101072188	80x65x80mm	Metal 3x 2½x3" Electric 3W Pressure Reducing Valve Angle - BSP DC Latch + 3W Sagiv
101072189	80mm	Metal 3" Electric 3W Pressure Reducing Valve Angle - BSP DC Latch + 3W Sagiv

RAF Metal Flanged Angle Electric 3-Way Pressure Reducing Valve With DC Latching Solenoid and 3-Way Sagiv

Product Number	Size	Description
101072190	80x65x80mm	Metal 3x 2½x3" Electric 3W Pressure Reducing Valve Angle - Flanged DC Latch + 3W Sagiv
101072191	80mm	Metal 3" Electric 3W Pressure Reducing Valve Angle - Flanged DC Latch + 3W Sagiv
101072192	100mm	Metal 4" Electric 3W Pressure Reducing Valve Angle - Flanged DC Latch + 3W Sagiv

Valves up to 150mm use a RAF PR 3-way Pressure Reducing pilot with standard Green Spring 0.4-4.5bar and Baccara G75 solenoid Pressure rating = 10 bar

Valves 200mm and above use a Brass 683 3-way pressure Reducing pilot with standard Yellow Spring 2.0-16.0 bar and a Gemsol solenoid Pressure rating = 16 bar

ARAD Pilot available on request for valves up to 150mm

RAF METAL VALVES



RAF Metal Threaded Electric 3-Way Pressure Sustaining Valve With 24VAC Solenoid and 3-Way Sagiv

Product Number	Size	Description
101072408	25mm	Metal 1" Electric 3W Pressure Sustaining Valve Inline - BSP 24VAC + 3W Sagiv
101072409	40mm	Metal 1½" Electric 3W Pressure Sustaining Valve Inline - BSP 24VAC + 3W Sagiv
101072410	50mm	Metal 2" Electric 3W Pressure Sustaining Valve Inline - BSP 24VAC + 3W Sagiv
101072411	80x65x80mm	Metal 3x 2½x3" Electric 3W Pressure Sustaining Valve Inline - BSP 24VAC + 3W Sagiv
101072412	80mm	Metal 3" Electric 3W Pressure Sustaining Valve Inline - BSP 24VAC + 3W Sagiv



RAF Metal Flanged Electric 3-Way Pressure Sustaining Valve With 24VAC Solenoid and 3-Way Sagiv

Product Number	Size	Description
101072413	50mm	Metal 2" Electric 3W Pressure Sustaining Valve Inline - Flanged 24VAC + 3W Sagiv
101072414	80x65x80mm	Metal 3x 2½x3" Electric 3W Pressure Sustaining Valve Inline - Flanged 24VAC + 3W Sagiv
101072415	80mm	Metal 3" Electric 3W Pressure Sustaining Valve Inline - Flanged 24VAC + 3W Sagiv
101072416	100x80x100mm	Metal 4x3x4" Electric 3W Pressure Sustaining Valve Inline - Flanged 24VAC + 3W Sagiv
101072417	100mm	Metal 4" Electric 3W Pressure Sustaining Valve Inline - Flanged 24VAC + 3W Sagiv
101072418	150x100x150mm	Metal 6x4x6" Electric 3W Pressure Sustaining Valve Inline - Flanged 24VAC + 3W Sagiv
101072419	150mm	Metal 6" Electric 3W Pressure Sustaining Valve Inline - Flanged 24VAC + 3W Sagiv
101072420	150mm	Metal 6" Electric 3W Pressure Sustaining Valve Inline Brass Pilot - Flanged 24VAC + 3W Sagiv
101072421	200mm	Metal 8" Electric 3W Pressure Sustaining Valve Inline Brass Pilot - Flanged 24VAC + 3W Sagiv
101072422	250mm	Metal 10" Electric 3W Pressure Sustaining Valve Inline Brass Pilot - Flanged 24VAC + 3W Sagiv
101072423	300mm	Metal 12" Electric 3W Pressure Sustaining Valve Inline Brass Pilot - Flanged 24VAC + 3W Sagiv



Valves up to 150mm use a RAF PR 3-way Pressure Sustaining Pilot with standard Green Spring 0.4-4.5bar and Baccara G75 solenoid Pressure rating = 10 bar

Valves 200mm and above use a Brass 683 3-way Pressure Sustaining Pilot with standard Yellow Spring 2.0-16.0 bar and a Gemsol solenoid Pressure rating = 16 bar

ARAD Pilot available on request for valves up to 150mm

RAF METAL VALVES



RAF Metal Threaded Electric 3-Way Pressure Sustaining Valve With DC Latching Solenoid and 3-Way Sagiv

Product Number	Size	Description
101072430	25mm	Metal 1" Electric 3W Pressure Sustaining Valve Inline - BSP DC Latch + 3W Sagiv
101072431	40mm	Metal 1½" Electric 3W Pressure Sustaining Valve Inline - BSP DC Latch + 3W Sagiv
101072432	50mm	Metal 2" Electric 3W Pressure Sustaining Valve Inline - BSP DC Latch + 3W Sagiv
101072433	80x65x80mm	Metal 3x 2½x3" Electric 3W Pressure Sustaining Valve Inline - BSP DC Latch + 3W Sagiv
101072434	80mm	Metal 3" Electric 3W Pressure Sustaining Valve Inline - BSP DC Latch + 3W Sagiv



RAF Metal Flanged Electric 3-Way Pressure Sustaining Valve With DC Latching Solenoid and 3-Way Sagiv

Product Number	Size	Description
101072435	50mm	Metal 2" Electric 3W Pressure Sustaining Valve Inline - Flanged DC Latch + 3W Sagiv
101072436	80x65x80mm	Metal 3x 2½x3" Electric 3W Pressure Sustaining Valve Inline - Flanged DC Latch + 3W Sagiv
101072437	80mm	Metal 3" Electric 3W Pressure Sustaining Valve Inline - Flanged DC Latch + 3W Sagiv
101072438	100x80x100mm	Metal 4x3x4" Electric 3W Pressure Sustaining Valve Inline - Flanged DC Latch + 3W Sagiv
101072439	100mm	Metal 4" Electric 3W Pressure Sustaining Valve Inline - Flanged DC Latch + 3W Sagiv
101072440	150x100x150mm	Metal 6x4x6" Electric 3W Pressure Sustaining Valve Inline - Flanged DC Latch + 3W Sagiv
101072441	150mm	Metal 6" Electric 3W Pressure Sustaining Valve Inline - Flanged DC Latch + 3W Sagiv
101072442	150mm	Metal 6" Electric 3W Pressure Sustaining Valve Inline Brass Pilot - Flanged DC Latch + 3W Sagiv
101072443	200mm	Metal 8" Electric 3W Pressure Sustaining Valve Inline Brass Pilot - Flanged DC Latch + 3W Sagiv
101072444	250mm	Metal 10" Electric 3W Pressure Sustaining Valve Inline Brass Pilot - Flanged DC Latch + 3W Sagiv
101072445	300mm	Metal 12" Electric 3W Pressure Sustaining Valve Inline Brass Pilot - Flanged DC Latch + 3W Sagiv



Valves up to 150mm use a RAF PR 3-way Pressure Sustaining Pilot with standard Green Spring 0.4-4.5bar and Baccara G75 solenoid Pressure rating = 10 bar

Valves 200mm and above use a Brass 683 3-way Pressure Sustaining Pilot with standard Yellow Spring 2.0-16.0 bar and a Gemsol solenoid Pressure rating = 16 bar

ARAD Pilot available on request for valves up to 150mm

RAF METAL VALVES



RAF Metal Threaded Angle Electric 3-Way Pressure Sustaining Valve 24VAC Solenoid + 3-Way Sagiv

Product Number	Size	Description
101072424	50mm	Metal 2" Electric 3W Pressure Sustaining Valve Angle - BSP 24VAC + 3W Sagiv
101072425	80x65x80mm	Metal 3x 2½x3" Electric 3W Pressure Sustaining Valve Angle - BSP 24VAC + 3W Sagiv
101072426	80mm	Metal 3" Electric 3W Pressure Sustaining Valve Angle - BSP 24VAC + 3W Sagiv

RAF Metal Flanged Angle Electric 3-Way Pressure Sustaining Valve With 24VAC Solenoid and 3-Way Sagiv

Product Number	Size	Description
101072427	80x65x80mm	Metal 3x 2½x3" Electric 3W Pressure Sustaining Valve Angle - Flanged 24VAC + 3W Sagiv
101072428	80mm	Metal 3" Electric 3W Pressure Sustaining Valve Angle - Flanged 24VAC + 3W Sagiv
101072429	100mm	Metal 4" Electric 3W Pressure Sustaining Valve Angle - Flanged 24VAC + 3W Sagiv

RAF Metal Threaded Angle Electric 3-Way Pressure Sustaining Valve With DC Latching Solenoid and 3-Way Sagiv

Product Number	Size	Description
101072446	50mm	Metal 2" Electric 3W Pressure Sustaining Valve Angle - BSP DC Latch + 3W Sagiv
101072447	80x65x80mm	Metal 3x 2½x3" Electric 3W Pressure Sustaining Valve Angle - BSP DC Latch + 3W Sagiv
101072448	80mm	Metal 3" Electric 3W Pressure Sustaining Valve Angle - BSP DC Latch + 3W Sagiv

RAF Metal Flanged Angle Electric 3-Way Pressure Sustaining Valve With DC Latching Solenoid and 3-Way Sagiv

Product Number	Size	Description
101072449	80x65x80mm	Metal 3x 2½x3" Electric 3W Pressure Sustaining Valve Angle - Flanged DC Latch + 3W Sagiv
101072450	80mm	Metal 3" Electric 3W Pressure Sustaining Valve Angle - Flanged DC Latch + 3W Sagiv
101072451	100mm	Metal 4" Electric 3W Pressure Sustaining Valve Angle - Flanged DC Latch + 3W Sagiv

Valves up to 150mm use a RAF PR 3-way Pressure Sustaining Pilot with standard Green Spring 0.4-4.5bar and Baccara G75 solenoid Pressure rating = 10 bar
ARAD Pilot available on request for valves up to 150mm

RAF METAL VALVES



RAF Metal Threaded Quick Pressure Relief Valve with Plastic Pilot

Product Number	Size	Description
AUV010041	25mm	Metal 1" Quick Relief Valve - BSP
AUV010042	40mm	Metal 1½" Quick Relief Valve - BSP
AUV010043	50mm	Metal 2" Quick Relief Valve - BSP
AUV010044	80x65x80mm	Metal 3x 2½x3" Quick Relief Valve - BSP
AUV010045	80mm	Metal 3" Quick Relief Valve - BSP

QPR with Bermad PC-3Q-P pilot, Tefen fittings and 8mm PE tube.
Pressure rating = 10 bar

RAF Metal Flanged Quick Pressure Relief Valve with Plastic Pilot

Product Number	Size	Description
AUV010046	50mm	Metal 2" Quick Relief Valve - Flanged
AUV010047	80x65x80mm	Metal 3x 2½x3" Quick Relief Valve - Flanged
AUV010048	80mm	Metal 3" Quick Relief Valve - Flanged
AUV010049	100x80x100mm	Metal 4x3x4" Quick Relief Valve - Flanged
AUV010050	100mm	Metal 4" Quick Relief Valve - Flanged

QPR with Bermad PC-3Q-P pilot, Tefen fittings and 8mm PE tube.
Pressure rating = 10 bar

RAF Metal Threaded Quick Pressure Relief Valve

Product Number	Size	Description
101013732	25mm	Metal 1" Quick Relief Valve - BSP
101010636	40mm	Metal 1½" Quick Relief Valve -BSP
101013730	50mm	Metal 2" Quick Relief Valve -BSP
101072777	80x65x80mm	Metal 3x 2½x3" Quick Relief Valve -BSP
101013731	80mm	Metal 3" Quick Relief Valve -BSP

QPR with Raphael P182 2-way brass pilot, pressure gauge, 10mm Nylon tubing and brass fittings.
Pressure rating = 16 bar

RAF METAL VALVES



RAF Metal Flanged Quick Pressure Relief Valve

Product Number	Size	Description
101072778	50mm	Metal 2" Quick Relief Valve - Flanged
101072779	80x65x80mm	Metal 3x 2½x3" Quick Relief Valve - Flanged
101072780	80mm	Metal 3" Quick Relief Valve - Flanged
101072781	100x80x100mm	Metal 4x3x4" Quick Relief Valve - Flanged
101072782	100mm	Metal 4" Quick Relief Valve - Flanged



RAF Metal Threaded Angle Quick Pressure Relief Valve

Product Number	Size	Description
101011702	50mm	Metal 2" Quick Relief Valve Angle - BSP
101072785	80x65x80mm	Metal 3x 2½x3" Quick Relief Valve Angle - BSP
101072786	80mm	Metal 3" Quick Relief Valve Angel - BSP



RAF Metal Flanged Angle Quick Pressure Relief Valve

Product Number	Size	Description
101072787	80x65x80mm	Metal 3x 2½x3" Quick Relief Valve Angle - Flanged
101072788	80mm	Metal 4" Quick Relief Valve Angle - Flanged
101072789	100mm	Metal 3" Quick Relief Valve Angle - Flanged



QPR with Raphael P182 2-way brass pilot, pressure gauge, 10mm Nylon tubing and brass fittings.
Pressure rating = 16 bar

RAF METAL VALVES



RAF Metal Threaded Single Level Float Valve

Product Number	Size	Description
AUV010051	25mm	Metal 1" Single Level Float Valve - BSP
AUV010052	40mm	Metal 1½" Single Level Float Valve - BSP
AUV010053	50mm	Metal 2" Single Level Float Valve - BSP
AUV010054	80x65x80mm	Metal 3x 2½x3" Single Level Float Valve - BSP
AUV010055	80mm	Metal 3" Single Level Float Valve - BSP

RAF Metal Flanged Single Level Float Valve

Product Number	Size	Description
AUV010056	50mm	Metal 2" Single Level Float Valve - Flanged
AUV010057	80x65x80mm	Metal 3x 2½x3" Single Level Float Valve - Flanged
AUV010058	80mm	Metal 3" Single Level Float Valve - Flanged
AUV010059	100x80x100mm	Metal 4 x 3 x 4" Single Level Float Valve - Flanged
AUV010060	100mm	Metal 4" Single Level Float Valve - Flanged
AUV010061	150x100x150mm	Metal 6 x 4 x 6" Single Level Float Valve - Flanged
AUV010062	150mm	Metal 6" Single Level Float Valve - Flanged
AUV010063	200mm	Metal 8" Single Level Float Valve - Flanged



RAF METAL VALVES



RAF Metal Threaded Dual Level Float Valve

Product Number	Size	Description
AUV010064	25mm	Metal 1" Dual Level Float Valve - BSP
AUV010065	40mm	Metal 1½" Dual Level Float Valve - BSP
AUV010066	50mm	Metal 2" Dual Level Float Valve - BSP
AUV010067	80x65x80mm	Metal 3x 2½x3" Dual Level Float Valve - BSP
AUV010068	80mm	Metal 3" Dual Level Float Valve - BSP

RAF Metal Flanged Dual Level Float Valve

Product Number	Size	Description
AUV010069	50mm	Metal 2" Dual Level Float Valve - Flanged
AUV010070	80x65x80mm	Metal 3x 2½x3" Dual Level Float Valve - Flanged
AUV010071	80mm	Metal 3" Dual Level Float Valve - Flanged
AUV010072	100x80x100mm	Metal 4 x 3 x 4" Dual Level Float Valve - Flanged
AUV010073	100mm	Metal 4" Dual Level Float Valve - Flanged
AUV010074	150x100x150mm	Metal 6 x 4 x 6" Dual Level Float Valve - Flanged
AUV010075	150mm	Metal 6" Dual Level Float Valve - Flanged
AUV010076	200mm	Metal 8" Dual Level Float Valve - Flanged



HIGH PRESSURE METAL VALVES



RAF Metal Threaded High Pressure Valves With Manual 3-Way Sagiv

Product Number	Size	Description
AUV010077	25mm	Metal 1" HP Manual Valve Inline - BSP + 3W Sagiv
101072661	40mm	Metal 1½" HP Manual Valve Inline - BSP + 3W Sagiv
101072662	50mm	Metal 2" HP Manual Valve Inline - BSP + 3W Sagiv
101072663	80x65x80mm	Metal 3x 2½x3" HP Manual Valve Inline - BSP + 3W Sagiv
101072664	80mm	Metal 3" HP Manual Valve Inline - BSP + 3W Sagiv

RAF Metal Flanged High Pressure Valves With Manual 3-Way Sagiv

Product Number	Size	Description
101072665	50mm	Metal 3" HP Manual Valve Inline - Flanged + 3W Sagiv
AUV010078	80x65x80mm	Metal 3x 2½x3" HP Manual Valve Inline - Flanged + 3W Sagiv
101072666	80mm	Metal 3" HP Manual Valve Inline - Flanged + 3W Sagiv
101072667	100x80x100mm	Metal 4x3x4" HP Manual Valve Inline - Flanged + 3W Sagiv
101072668	100mm	Metal 4" HP Manual Valve Inline - Flanged + 3W Sagiv
101072669	150x100x150mm	Metal 6x4x6 HP Manual Valve Inline - Flanged + 3W Sagiv
101072670	150mm	Metal 6" HP Manual Valve Inline - Flanged + 3W Sagiv
101072671	200mm	Metal 8" HP Manual Valve Inline - Flanged + 3W Sagiv
101072672	250mm	Metal 10" HP Manual Valve Inline - Flanged + 3W Sagiv
101072673	300mm	Metal 12" HP Manual Valve Inline - Flanged + 3W Sagiv



HP valves fitted with nylon tube and brass fittings.
Pressure rating 16 bar

HIGH PRESSURE METAL VALVES



RAF Metal Threaded Angle High Pressure Valves With 3-Way Sagiv

Product Number	Size	Description
101072674	50mm	Metal 2" HP Manual Valve Angle - BSP + 3W Sagiv
101072675	80x65x80mm	Metal 3x 2½ x3" HP Manual Valve Angle - BSP + 3W Sagiv
101072676	80mm	Metal 3" HP Manual Valve Angle - BSP + 3W Sagiv

RAF Metal Flanged Angle High Pressure Valves With 3-Way Sagiv

Product Number	Size	Description
101072677	80x65x80mm	Metal 3x 2½x3" HP Manual Valve Angle - Flanged + 3W Sagiv
101072678	80mm	Metal 3" HP Manual Valve Angle - Flanged + 3W Sagiv
101072679	100mm	Metal 4" HP Manual Valve Angle - Flanged + 3W Sagiv

RAF Metal Threaded High Pressure Valves With 24VAC Solenoid and 3-Way Sagiv

Product Number	Size	Description
101072130	25mm	Metal 1" HP Electric Valve Inline - BSP 24VAC + 3W Sagiv
101072131	40mm	Metal 1½" HP Electric Valve Inline - BSP 24VAC + 3W Sagiv
101072132	50mm	Metal 2" HP Electric Valve Inline - BSP 24VAC + 3W Sagiv
AUV010079	80x65x80mm	Metal 3x 2½x3" HP Electric Valve Inline - BSP 24VAC + 3W Sagiv
101072133	80mm	Metal 3" HP Electric Valve Inline - BSP 24VAC + 3W Sagiv

RAF Metal Flanged High Pressure Valves With 24VAC Solenoid and 3-Way Sagiv

Product Number	Size	Description
101072135	50mm	Metal 2" HP Electric Valve Inline - Flanged 24VAC + 3W Sagiv
AUV010080	80x65x80mm	Metal 3x 2½x3" HP Electric Valve Inline - Flanged 24VAC + 3W Sagiv
101072136	80mm	Metal 3" HP Electric Valve Inline - Flanged 24VAC + 3W Sagiv
101072138	100x80x100mm	Metal 4x3x4" HP Electric Valve Inline - Flanged 24VAC + 3W Sagiv
101072139	100mm	Metal 4" HP Electric Valve Inline - Flanged 24VAC + 3W Sagiv
101072140	150x100x150mm	Metal 6x4x6" HP Electric Valve Inline - Flanged 24VAC + 3W Sagiv
101072141	150mm	Metal 6" HP Electric Valve Inline - Flanged 24VAC + 3W Sagiv
101072105	200mm	Metal 8" Electric Valve Inline - Flanged 24VAC + 3W Sagiv
101072106	250mm	Metal 10" Electric Valve Inline - Flanged 24VAC + 3W Sagiv
101072107	300mm	Metal 12" Electric Valve Inline - Flanged 24VAC + 3W Sagiv



HP electric valves use Gemsol solenoids fitted with nylon tube and brass fittings. Pressure rating 16 bar

HIGH PRESSURE METAL VALVES



RAF Metal Threaded Angle High Pressure Valves With 24VAC Solenoid and 3-Way Sagiv

Product Number	Size	Description
101072145	50mm	Metal 2" HP Electric Valve Angle - BSP 24VAC + 3W Sagiv
101072146	80x65x80mm	Metal 3x 2½x3" HP Electric Valve Angle - BSP 24VAC + 3W Sagiv
101072147	80mm	Metal 3" HP Electric Valve Angle - BSP 24VAC + 3W Sagiv

RAF Metal Threaded Angle High Pressure Valves With 24VAC Solenoid and 3-Way Sagiv

Product Number	Size	Description
101072148	80x65x80mm	Metal 3x 2½x3" HP Electric Valve Angle - Flanged 24VAC + 3W Sagiv
101072149	80mm	Metal 3" HP Electric Valve Angle - Flanged 24VAC + 3W Sagiv
101072150	100mm	Metal 4" HP Electric Valve Angle - Flanged 24VAC + 3W Sagiv
AUV010081	150mm	Metal 6" HP Electric Valve Angle - Flanged 24VAC + 3W Sagiv

RAF Metal High Pressure Threaded 3-Way Pressure Reducing Valve With 3-Way Sagiv

Product Number	Size	Description
101072744	50mm	Metal 2" HP 3W Pressure Reducing Valve Inline - BSP + Sagiv
101072745	80x65x80mm	Metal 3x 2½x3" HP 3W Pressure Reducing Valve Inline - BSP + Sagiv
101072746	80mm	Metal 3" 3W HP Pressure Reducing Valve Inline - BSP + Sagiv

RAF Metal High Pressure Flanged 3-Way Pressure Reducing Valve With 3-Way Sagiv

Product Number	Size	Description
101072747	50mm	Metal 2" HP 3W Pressure Reducing Valve Inline - Flanged + Sagiv
101072748	80x65x80mm	Metal 3x 2½x3" HP 3W Pressure Reducing Valve Inline - Flanged + Sagiv
101072749	80mm	Metal 3" HP 3W Pressure Reducing Valve Inline - Flanged + Sagiv
101072750	100x80x100mm	Metal 4x3x4" Pressure Reducing Valve Inline - Flanged + Sagiv
101072751	100mm	Metal 4" HP 3W Pressure Reducing Valve Inline - Flanged + Sagiv
101072752	150x100x150mm	Metal 6x4x6" HP 3W Pressure Reducing Valve Inline - Flanged + Sagiv
101072753	150mm	Metal 6" HP 3W Pressure Reducing Valve Inline - Flanged + Sagiv



HP PRV use brass 3-way pilot fitted with nylon tube and brass fitting. Pressure gauge included Pressure rating 16 bar

HIGH PRESSURE METAL VALVES



RAF Metal High Pressure Threaded 2-Way Pressure Reducing Valve

Product Number	Size	Description
101072761	50mm	Metal 2" HP 2W Pressure Reducing Valve Inline - BSP
101072762	80x65x80mm	Metal 3x 2½x3" HP 2W Pressure Reducing Valve Inline - BSP
101072763	80mm	Metal 3" HP 2W Pressure Reducing Valve Inline - BSP

RAF Metal High Pressure Flanged 2-Way Pressure Reducing Valve

Product Number	Size	Description
101072764	50mm	Metal 2" HP 2W Pressure Reducing Valve - Flanged
101072765	80x65x80mm	Metal 3x 2½x3" HP 2W Pressure Reducing Valve Inline - Flanged
101072766	80mm	Metal 3" HP 2W Pressure Reducing Valve Inline - Flanged
101072767	100x80x100mm	Metal 4x3x4" HP 2W Pressure Reducing Valve Inline - Flanged
101072768	100mm	Metal 4" HP 2W Pressure Reducing Valve Inline - Flanged
101072769	150x100x150mm	Metal 6x4x6" HP 2W Pressure Reducing Valve Inline - Flanged
101072770	150mm	Metal 6" HP 2W Pressure Reducing Valve Inline - Flanged

HP PRV use brass 2-way pilot fitted with nylon tube and brass fitting. Pressure gauge included Pressure rating 16 bar

RAF Metal High Pressure Threaded Angle 3-Way Pressure Reducing Valve With 3-Way Sagiv

Product Number	Size	Description
101072754	50mm	Metal 2" HP 3W Pressure Reducing Valve Angle - BSP + Sagiv
101072755	80x65x80mm	Metal 3x 2½x3" HP 3W Pressure Reducing Valve Angle - BSP + Sagiv
101072756	80mm	Metal 3" HP 3W Pressure Reducing Valve Angle - BSP + Sagiv

RAF Metal High Pressure Flanged Angle 3-Way Pressure Reducing Valve With 3-Way Sagiv

Product Number	Size	Description
101072757	80x65x80mm	Metal 3x 2½x3" HP 3W Pressure Reducing Valve Angle - Flanged + Sagiv
101072758	80mm	Metal 3" HP 3W Pressure Reducing Valve Angle - Flanged + Sagiv
101072759	100mm	Metal 4" HP 3W Pressure Reducing Valve Angle - Flanged + Sagiv

HP PRV use brass 2-way Pilot fitted with nylon tube and brass fitting. Pressure gauge included Pressure rating 16 bar

HIGH PRESSURE METAL VALVES



RAF Metal High Pressure Threaded Angle 2-Way Pressure Reducing Valve

Product Number	Size	Description
101072771	50mm	Metal 2" HP 2W Pressure Reducing Valve Angle - BSP
101072772	80x65x80mm	Metal 3x 2½x3" HP 2W Pressure Reducing Valve Angle - BSP
101072773	80mm	Metal 3" HP 2W Pressure Reducing Valve Angle - BSP

RAF Metal High Pressure Flanged Angle 2-Way Pressure Reducing Valve

Product Number	Size	Description
101072774	80x65x80mm	Metal 3x 2½x3" HP 2W Pressure Reducing Valve Angle - Flanged
101072775	80mm	Metal 3" HP 2W Pressure Reducing Valve Angle - Flanged
101072776	100mm	Metal 4" HP 2W Pressure Reducing Valve Angle - Flanged

RAF Metal High Pressure Threaded 3-Way Pressure Sustaining Valve With 3-Way Sagiv

Product Number	Size	Description
AUV010082	50mm	Metal 2" HP 3W Pressure Sustaining Valve Inline - BSP + Sagiv
AUV010083	80x65x80mm	Metal 3x 2½x3" HP 3W Pressure Sustaining Valve Inline - BSP + Sagiv
AUV010084	80mm	Metal 3" 3W HP Pressure Sustaining Valve Inline - BSP + Sagiv

RAF Metal High Pressure Flanged 3-Way Pressure Sustaining Valve With 3-Way Sagiv

Product Number	Size	Description
AUV010085	50mm	Metal 2" HP 3W Pressure Sustaining Valve Inline - Flanged + Sagiv
AUV010086	80x65x80mm	Metal 3x 2½x3" HP 3W Pressure Sustaining Valve Inline - Flanged + Sagiv
AUV010087	80mm	Metal 3" HP 3W Pressure Sustaining Valve Inline - Flanged + Sagiv
AUV010088	100x80x100mm	Metal 4x3x4" Pressure Sustaining Valve Inline - Flanged + Sagiv
AUV010089	100mm	Metal 4" HP 3W Pressure Sustaining Valve Inline - Flanged + Sagiv
AUV010090	150x100x150mm	Metal 6x4x6" HP 3W Pressure Sustaining Valve Inline - Flanged + Sagiv
101072377	150mm	Metal 6" HP 3W Pressure Sustaining Valve Inline - Flanged + Sagiv



RAF Metal High Pressure Threaded 2-Way Pressure Sustaining Valve

Product Number	Size	Description
AUV010091	50mm	Metal 2" HP 2W Pressure Sustaining Valve Inline - BSP
AUV010092	80x65x80mm	Metal 3x 2½x3" HP 2W Pressure Sustaining Valve Inline - BSP
AUV010093	80mm	Metal 3" HP 2W Pressure Sustaining Valve Inline - BSP

HIGH PRESSURE METAL VALVES



RAF Metal High Pressure Flanged 2-Way Pressure Sustaining Valve

Product Number	Size	Description
AUV010094	50mm	Metal 2" HP 2W Pressure Sustaining Valve - Flanged
AUV010095	80x65x80mm	Metal 3x 2½x3" HP 2W Pressure Sustaining Valve Inline - Flanged
AUV010096	80mm	Metal 3" HP 2W Pressure Sustaining Valve Inline - Flanged
AUV010097	100x80x100mm	Metal 4x3x4" HP 2W Pressure Sustaining Valve Inline - Flanged
AUV010098	100mm	Metal 4" HP 2W Pressure Sustaining Valve Inline - Flanged
AUV010099	150x100x150mm	Metal 6x4x6" HP 2W Pressure Sustaining Valve Inline - Flanged
AUV010100	150mm	Metal 6" HP 2W Pressure Sustaining Valve Inline - Flanged

RAF Metal High Pressure Threaded Electric 3-Way Pressure Reducing Valve With 24VAC Solenoid

Product Number	Size	Description
101072193	40mm	Metal 1½" HP Electric 3W Pressure Reducing Valve Inline - BSP 24VAC + 3W Sagiv
101072194	50mm	Metal 2" HP Electric 3W Pressure Reducing Valve Inline - BSP 24VAC + 3W Sagiv
101072195	80x65x80mm	Metal 3x 2½x3" HP Electric 3W Pressure Reducing Valve Inline - BSP 24VAC + 3W Sagiv
101072196	80mm	Metal 3" HP Electric 3W Pressure Reducing Valve Inline - BSP 24VAC + 3W Sagiv

RAF Metal High Pressure Flanged Electric 3-Way Pressure Reducing Valve With 24VAC Solenoid

Product Number	Size	Description
101072197	50mm	Metal 2" HP Electric Pressure Reducing Valve Inline - Flanged 24VAC + 3W Sagiv
101072198	80x65x80mm	Metal 3x 2½x3" HP Electric Pressure Reducing Valve Inline - Flanged 24VAC + 3W Sagiv
101072199	80mm	Metal 3" HP Electric Pressure Reducing Valve Inline - Flanged 24VAC + 3W Sagiv
101072200	100x80x100mm	Metal 4x3x4" HP Electric Pressure Reducing Valve Inline - Flanged 24VAC + 3W Sagiv
101072201	100mm	Metal 4" HP Electric Pressure Reducing Valve Inline - Flanged 24VAC + 3W Sagiv
101072202	150x100x150mm	Metal 6x4x6" HP Electric Pressure Reducing Valve Inline - Flanged 24VAC + 3W Sagiv
101072165	150mm	Metal 6" HP Electric Pressure Reducing Valve Inline - Flanged 24VAC + 3W Sagiv



HP PRV use brass 2-way Pilot fitted with nylon tube and brass fitting. Pressure gauge included
Pressure rating 16 bar

HIGH PRESSURE METAL VALVES



RAF Metal High Pressure Threaded Angle Electric 3-Way Pressure Reducing Valve With 24VAC Solenoid and 3-Way Sagiv

Product Number	Size	Description
101072203	50mm	Metal 2" HP Electric 3W Pressure Reducing Valve Angle - BSP 24VAC + 3W Sagiv
101072204	80x65x80mm	Metal 3x 2½x3" HP Electric 3W Pressure Reducing Valve Angle - BSP 24VAC + 3W Sagiv
101072205	80mm	Metal 3" HP Electric 3W Pressure Reducing Valve Angle - BSP 24VAC + 3W Sagiv

RAF Metal High Pressure Flanged Angle Electric 3-Way Pressure Reducing Valve With 24VAC Solenoid and 3-Way Sagiv

Product Number	Size	Description
101072206	80x65x80mm	Metal 3x 2½x3" HP Electric Pressure Reducing Valve Angle - Flanged 24VAC + 3W Sagiv
101072207	80mm	Metal 3" HP Electric Pressure Reducing Valve Angle - Flanged 24VAC + 3W Sagiv
101072208	100mm	Metal 4" HP Electric Pressure Reducing Valve Angle - Flanged 24VAC + 3W Sagiv

HP PRV use brass 2-way Pilot fitted with nylon tube and brass fitting. Pressure gauge included
 Pressure rating 16 bar

TEFEN FITTINGS



Tefen | Fittings

Product Number	Description	
101004241	Tefen Male Connector 8 mm x 1/8"	
101004243	Tefen Male Connector 8 mm x 1/4"	
101004238	Tefen Union Connector 8 mm x 8 mm	
101004317	Tefen Male Elbow 8 mm x 1/4"	
101004315	Tefen Male Elbow 8 mm x 1/8"	
101004272	Tefen Male Branch Tee 8 mm x 1/8" x 8 mm	
101004269	Tefen Male Branch Tee 8 mm x 1/4" x 8 mm	
101004292	Tefen Male Run Tee 8 mm x 8 mm x 1/8"	
101004296	Tefen Male Run Tee 8 mm x 8 mm x 1/4"	
101004293	Tefen Male Run Tee 8 mm x 1/8" x 1/4"	
101004267	Tefen Union Tee 8 mm x 8 mm x 8 mm	
101005937	Pressure Test Point Tee Assembly	
101004206	Tefen Plug 1/8"	
101004207	Tefen Plug 1/4"	
101004209	Tefen Plug 1/2"	
101004102	Bush 1/4" x 1/8" MxF	
101004105	Bush 1/2" x 1/4" MxF	
101004110	Bush 1/8" x 1/4" MxF	
101004127	Nipple 1/8" x 1/8"	
101004128	Nipple 1/4" x 1/4"	
101004149	Nipple 1/4" x 1/8"	
101004065	Socket 1/8" x 1/8"	
101004066	Socket 1/4" x 1/4"	

VALVE ACCESSORIES



Baccara Solenoids

Product Number	Description	
101014243	Baccara G75 Coil 24VAC 1.6mm 3w N.O without Diode	
101064623	Baccara G75 Coil 24VAC 1.6mm 3w N.O with Diode	
101014244	Baccara G75 Coil 24VAC 1.2mm 3w N.C	
101071546	Baccara G75-A3P 3Way DC Latch 1/8" 3 way N.O	
101065058	Baccara G75-A3P 3Way DC Latch 1/8" 3 way N.C	
101071387	Baccara G75-VM Manifold with DC Latch 9Ω Coil - Left	
101071534	Baccara G75-VM Manifold with DC Latch 9Ω Coil - Middle	
101071535	Baccara G75-VM Manifold with DC Latch 9Ω Coil - Right	
101071536	Baccara G75-VSA Latch Stand Alone unit-1/8" BSP N.O	
101071537	Baccara G75-VSA Latch Stand Alone unit-1/8" BSP N.C	

Gemsol Solenoid Coils

Product Number	Description	
101007826	Gemsol Solenoid Coil 12V DC 10W with Connector	
101007824	Gemsol Solenoid Coil 24V DC 10W with Connector	
101007821	Gemsol Solenoid Coil 24V AC 5.5W with Connector	
101007749	Gemsol Solenoid Coil 24V AC 8W with Connector	
101007823	Gemsol Solenoid Coil 110V AC 8W with Connector	
101007828	Gemsol Solenoid Coil 240V AC 8W with Connector	



Gemsol Solenoids (Brass Base)

Product Number	Description	
101007794	Gemsol Brass Base 1.6 mm Normally Open 1/4"	
101007808	Gemsol Brass Base 2.4 mm Normally Open 1/8"	
101007793	Gemsol Brass Base 3.0 mm Normally Open 1/4"	
101007801	Gemsol Brass Base 1.6 mm Normally Closed 1/4"	
101007800	Gemsol Brass Base 2.4 mm Normally Closed 1/8"	
101007795	Gemsol Brass Base 3.0 mm Normally Closed 1/4"	









VALVE ACCESSORIES





DC Latch Solenoids

Product Number	Description	
WT12918	Bermad S-982 12-50V DC Latch with Plastic Base 2 wire	
101007760	Bermad S-985 12-50V DC Latch with Plastic Base 3 wire	
101071556	Gemsol Latch 1.6mm w/Base and Coil- 1/8" - 13Ω	
101071557	Gemsol Latch 2.4mm w/Base and Coil- 1/8" - 13Ω	



Valve Accessories

Product Number	Description	
101004587	Sagiv Brass 3-Way Tap 1/4" MBSP + 3 x 1/4" FBSP	
101004583	Sagiv Brass 3-Way Tap 1/4" MBSP + 3 x 1/8" FBSP	
101064329	Plastic Control Shuttle Tee 8mm x 1/8" x 8mm	
101072028	Brass 1/4" Shuttle Tee	
101000740	Needle Valve 1/4"	
101005931	Plastic Pressure Test point 1/4"	
101005929	Brass Needle for Pressure Check Point	
101008207	Barbed Pressure Test Point	
101005935	Pressure Check Point Cap Only	
101005932	Gasket for Pressure Check Point	
101071558	G75 Digital Differential Pressure Gauge Switch With Bracket	

Finger Filters

Product Number	Description	
101000706	Finger Filter Plastic 1/8" F x 1/4" M	
101072034	Finger Filter Brass 1/4" F x 1/4" M	
101072035	Finger Filter Brass 1/4" F x 1/2" M	

Hydraulic Relays + Galsol

Product Number	Description	
101034716	Plastic Hydraulic Relay Double Chamber (1 Bar)	
101000723	Plastic Hydraulic Relay - Galit	
101039012	Galsol Solenoid Galit + Baccara 24VAC coil	
101007776	Galsol Solenoid Galit + Baccara 9Ω DC Latch Coil	

VALVE ACCESSORIES

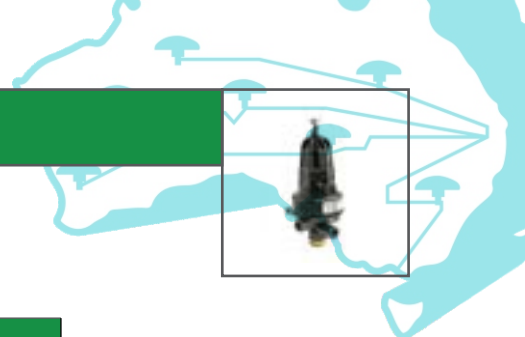

Hydraulic Control Tube

Product Number	Description
101002262	Control Tube 8 mm I 500 m Roll No Stripe
101002260	Control Tube 8 mm I 500 m Roll Green Stripe
101002258	Control Tube 8 mm I 500 m Roll Red Stripe
101002256	Control Tube 8 mm I 500 m Roll White Stripe
101002257	Control Tube 8 mm I 500 m Roll Yellow Stripe
101034712	Control Flexible Reinforced Nylon Tube 3/8" (meter)



Liquid Pressure Gauges

Product Number	Description
101048752	Pressure Gauge Liquid 2.5 Bar (35 psi) Bottom Inlet 1/4" BSP Male Diameter 63 mm (2.5")
101048753	Pressure Gauge Liquid 4.0 Bar (60 psi) Bottom Inlet 1/4" BSP Male Diameter 63 mm (2.5")
101048754	Pressure Gauge Liquid 6.0 Bar (90 psi) Bottom Inlet 1/4" BSP Male Diameter 63 mm (2.5")
101048755	Pressure Gauge Liquid 10 Bar (150 psi) Bottom Inlet 1/4" BSP Male Diameter 63 mm (2.5")



Dry Pressure Gauges

Product Number	Description
101048756	Pressure Gauge Dry 4.0 Bar (60 psi) Bottom Inlet 1/4" BSP Male Diameter 63 mm (2.5")
101048757	Pressure Gauge Dry 6.0 Bar (90 psi) Bottom Inlet 1/4" BSP Male Diameter 63 mm (2.5")
101048758	Pressure Gauge Dry 10.0 Bar (150 psi) Bottom Inlet 1/4" BSP Male Diameter 63 mm (2.5")



Galit Springs & Accessories





Product Number	Description
101005104	Yellow Spring to Suit Galit (5-10m)
101005105	Green Spring to Suit Galit (10-15m)
101005106	White Spring to Suit Galit (15-20m)
101005107	Red Spring to Suit Galit (20-25m)
101005090	TED Device
101005047	Signal Amplifier for Galit



PILOTS



Plastic Pilots

Product Number	Description	
101061668	RAF PR Plastic Pressure Reducing 3-way Pilot - Green Spring	
101071821	RAF PR Plastic Pressure Reducing 3-way Pilot - Yellow Spring	
101071822	RAF PR Plastic Pressure Reducing 3-way Plastic Pilot - Red Spring	
101071939	RAF PSR Plastic Pressure Reducing/Sustaining 3-way Pilot - Green Spring	
101071952	RAF PSR Plastic Pressure Reducing/Sustaining 3-way Pilot - Yellow Spring	
101071962	RAF PSR Plastic Pressure Reducing/Sustaining 3-way Pilot - Red Spring	
101012477	ARAD Pressure Reducing/Sustaining 3- way Pilot - Grey Spring	
101012476	ARAD Pressure Reducing/Sustaining 3- way Pilot - Green Spring	
101072036	ARAD Pressure Reducing/Sustaining 3- way Pilot - Blue Spring	
WT12560	Bermad PC-3Q-P Plastic Quick Relief Pilot 1.0-10.0 bar	

Metal Pilots

Product Number	Description	
101071815	Pressure Reducing 3-way Brass Pilot P683 - Red Spring	
101071816	Pressure Reducing 3-way Brass Pilot P683 - Green Spring	
101013987	Pressure Reducing 3-way Brass Pilot P683 - Yellow Spring	
101071819	Pressure Sustaining 3-way Brass Pilot P683S Green Spring	
101071820	Pressure Sustaining 3-way Brass Pilot P683S Yellow Spring	
101071805	Pressure Reducing 2-way Brass Pilot P162 - Red Spring	
101071806	Pressure Reducing 2-way Brass Pilot P162 - Green Spring	
101013599	Pressure Reducing 2-way Brass Pilot P162 - Yellow Spring	
101071813	Pressure Reducing 2-way Brass Pilot P161 - Red Spring	
101071814	Pressure Reducing 2-way Brass Pilot P161 - Green Spring	
101013597	Pressure Reducing 2-way Brass Pilot P161 - Yellow Spring	
101071817	Pressure Sustaining 2-way Brass Pilot P182 - Red Spring	
101071818	Pressure Sustaining 2-way Brass Pilot P182 - Green Spring	
101013992	Pressure Sustaining 2-way Brass Pilot P182 - Yellow Spring	
101013989	Pressure Sustaining 2-way Brass Pilot P181 - Red Spring	
101013990	Pressure Sustaining 2-way Brass Pilot P181 - Green Spring	
101013988	Pressure Sustaining 2-way Brass Pilot P181 - Yellow Spring	

VALVE ACCESSORIES

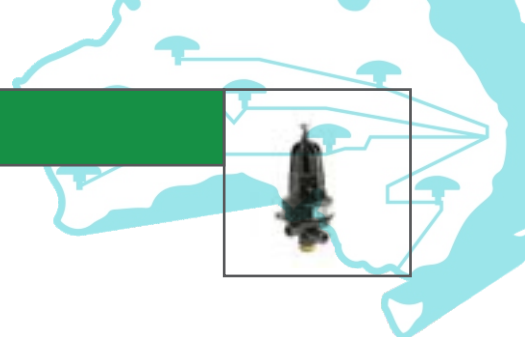

Float level Pilots

Product Number	Description
101013999	Raphael P73 Dual Level Float Pilot

Pilot Springs

Product Number	Description
101071996	Plastic PR & PSR Pilot Green Spring 0.5 - 4.5 Bar
101071997	Plastic PR & PSR Pilot Yellow Spring 0.3 - 3 Bar
101071998	Plastic PSR & PS Pilot Red Spring 1 - 7.5 Bar
101072001	Arad Plastic Pilot Grey Spring 0.8-7 Bar
101072002	Arad Plastic Pilot Green Spring 0.8-2.9 Bar
101072003	Arad Plastic Pilot Blue Spring 0.5-1.5 Bar
101071968	P162, P182 & P683 Red Spring 0.5-7 Bar
101071991	P162, P182 & P683 Green Spring 1.5-12 Bar
101071993	P162, P182 & P683 Yellow Spring 2-16 Bar
101071994	P161 & P181 Pilot Red Spring 0.5-5 Bar
101071995	P161 & P181 Pilot Green Spring 1-9 Bar
101000726	P161 & P181 Pilot Yellow Spring 2-15 Bar



VALVE SPARE PARTS



Valve Spare Parts

Product Number	Description
11337GR	Diaphragm to Suit Plastic 1 ½" and 2" Valve
11327GR	Diaphragm to Suit Plastic 2½", 2"S and 3" Valve
11304GR	Diaphragm to Suit Plastic 3"S and 4" Valve
21095GR	Diaphragm to Suit Metal 1 & 1½" Valve
101010755	Soft Diaphragm to Suit Metal 1 & 1½" Valve
101000685	Diaphragm to Suit Metal 2" Valve
101000692	Soft Diaphragm to Suit Metal 2" Valve
101000686	Diaphragm to Suit Metal 2½" Valve
101000693	Soft Diaphragm to Suit Metal 2½" Valve
101000687	Diaphragm to Suit Metal 3" Valve
11012/60GR	Soft Diaphragm to Suit Metal 3" Valve
101000688	Diaphragm to Suit Metal 4" Valve
101010756	Soft Diaphragm to Suit Metal 4" Valve
101010757	Soft Diaphragm to Suit Metal 6" Valve
DIAPHRRAF06	Diaphragm to Suit Metal 6" Valve
101062834	Diaphragm to Suit Metal 8" Valve
DIAPHRRAF10	Diaphragm to Suit Metal 10" Valve
101061719	Diaphragm to Suit Metal 12" Valve
FLRAFP030	80mm Flange Adaptor for plastic valves
FLRAFP040	100mm Flange Adaptor for plastic valves





RIVULIS VALVES



Rivulis has a range of air valves, vacuum breakers, plastic and metal hydraulic valves, valve accessories (solenoids, fittings and spare parts), hydraulic control tube and pressure gauges.

For Assistance please contact Michael: 0488 917 285 or michael@irrigationdirect.com.au