



Irrigation  
direct.com.au

# *STOCK TROUGH, VALVES & FITTINGS*





Irrigation  
direct.com.au

# ***CONCRETE TROUGH FITTINGS***



DESCRIPTION

CODE

SIZE

**BRASS INSERTS****LARGE FLANGED HEX NUTS**

	Part No.	Dimensions
	NL25	1" <i>BSP</i>
NL32	1 1/4" <i>BSP</i>	
NL40	1 1/2" <i>BSP</i>	
NL50	2" <i>BSP</i>	

**DRAIN INSERTS AND FLUSH CAPS - Suitable for Troughs and Tanks**

	Part No.	Dimensions
	INB2BSP	2" <i>BSP</i>
CW50	2" CAP TO SUIT	
INB212BSP	2 1/2" <i>BSP</i>	
CW55	2 1/2" CAP TO SUIT	
INB3BSP	3" <i>BSP</i>	
CW80	3" CAP TO SUIT	
S84112	4" DRAIN INSERT	
CW84	4" CAP TO SUIT	

**INLET CONNECTION INSERTS - When thread required both sides of wall**

	Part No.	Dimensions BSP x 2" (50mm) Long
	SB252	1" <i>BSP</i> x 2" Long *
SB322	1 1/4" <i>BSP</i> x 2" Long *	
SB402	1 1/2" <i>BSP</i> x 2" Long *	
SB502	2" <i>BSP</i> x 2" Long *	

\*Other lengths available on request

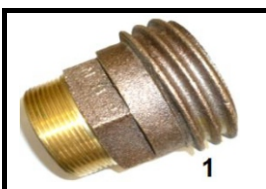
**FIRE HOSE ADAPTORS (VIC/SA/TAS ONLY)**

1

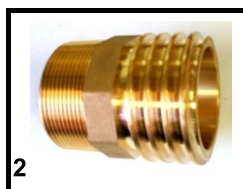

2

2 1/2" *VIC. CFA Fire Hose Adaptor. 3 T.P.I. to CFA Specifications, with 2" Male Thread on other end. (Brass)*

HN50CFA	2 1/2" CFA-VIC. ONLY	1
HN65CFA	2 1/2" X 2 1/2" CFA-VIC. C	2

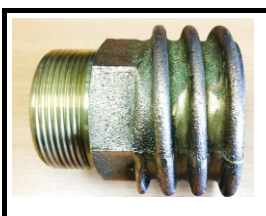

64mm SA CFS Fire Hose Adaptor 64mm LONDON ROUND THREAD  
to CFS Specifications, with 2" Male Thread on the other end.

HN64CFS	64mm CFS-SA ONLY
---------	------------------

PRICES DO NOT INCLUDE 'GST' AND MAY BE SUBJECT TO CHANGE WITHOUT NOTICE



## 21. TROUGH ACCESSORIES

### • BRASS TROUGH SOCKETS & PLUGS

#### BRASS TROUGH INLET SOCKETS\*

Threaded both ends

CODE	DESCRIPTION
SB403	1½" BSPF x 3" Long
SB503	2" BSPF x 3" Long
SB504	2" BSPF x 4" Long
SB50212	2" BSPF x 2½" Long



(\* Other sizes available on request - POA

#### BRASS TROUGH DRAIN SOCKETS\*

Threaded one end only

CODE	DESCRIPTION
S403	1½" BSPF x 3" Long
S503	2" BSPF x 3" Long
S802	3" BSPF x 2" Long
S803	3" BSPF x 3" Long
S842	3½" BSPF x 2" Long
S84234	3½" BSPF x 2¾" Long
S844B	4" BSPF x 4" Long



(\* Other sizes available on request

**Measuring Note: Measure Threaded Female Inside Diameter of Socket at Lowest Thread Point to Gain the Correct Size for Cap to fit – Refer Arrow on Photo**

#### BRASS CAPS WITH WASHERS (PLUGS)

CODE	DESCRIPTION
CW40	1½" BSPM Cap & Washer (Thread OD ~ 48mm)
CW50	2" BSPM Cap & Washer (Thread OD ~ 61mm)
CW65	2½" BSPM Cap & Washer (Thread OD ~ 76mm)
CW80	3" BSPM Cap & Washer (Thread OD ~ 90mm)
CW84	3½" BSPM Cap & Washer (Thread OD ~ 100mm)
CW84B	4" BSPM Cap & O-ring seal (Thread OD ~ 110mm)



**Measuring Note: Measure Threaded Male Outside Diameter of Cap at Highest Point – Refer Arrow on Photo**

#### BLACK WASHERS FOR BRASS CAPS

CODE	DESCRIPTION
WP40	1½" Square Profile Washer
WP50	2" Square Profile Washer
WP65	2½" Square Profile Washer
WP80	3" Square Profile Washer
WP84	3½" Square Profile Washer
WP84B	4" O-ring seal washer ORBS348



**Correct Measuring Note: Measure either Socket or Cap – Refer Arrows on Photo's above**

CODE | SIZE"

**FLANGED OUTLETS COMPLETE**



Brass allthread supplied complete with two nuts and fibre washers.  
**Note longer lengths made to order.**

**5" Long**

	Size x Length			NUT I.D.	NUT O.D.
FO255	1"	x	5"	33mm	65mm
FO325	1 1/4"	x	5"	38mm	76mm
FO405	1 1/2"	x	5"	45mm	82mm
FO505	2"	x	5"	58mm	98mm

**6" Long**

FO256	1"	x	6"	33mm	65mm
FO326	1 1/4"	x	6"	38mm	76mm
FO406	1 1/2"	x	6"	45mm	82mm
FO506	2"		6"	58mm	98mm

**Larger dimensions**

FO80412	3"	x	4 1/2"	86mm	128mm
FO809	3"	x	9"	86mm	128mm
FO844	4"	x	4"	110mm	168mm
FO848	4"	x	8"	110mm	168mm
FO866	6"	x	6"	162mm	255mm
FO8612	6"	x	12"	162mm	255mm

**10" Long**

	diam.	x	length	NUT I.D.	NUT O.D.
FO2010	3/4"	x	10"	23mm	55mm
FO2510	1"	x	10"	33mm	65mm
FO3210	1 1/4"	x	10"	38mm	76mm
FO4010	1 1/2"	x	10"	45mm	82mm
FO5010	2"	x	10"	58mm	98mm

**12" Long**

FO2512	1"	x	12"	33mm	65mm
FO3212	1 1/4"	x	12"	38mm	76mm
FO4012	1 1/2"	x	12"	45mm	82mm
FO5012	2"	x	12"	58mm	98mm

**CONCRETE TANK LINER REPAIR OUTLETS COMPLETE**



This fitting is fabricated especially for use with liners in old tanks.  
 One nut bonded to 10" allthread, 25mm from end. Two loose nuts, two rubber, two fibre washers.

	diam.	x	length	NUT I.D.	NUT O.D.
LFO2510	1"	x	10"	33mm	65mm
LFO3210	1 1/4"	x	10"	38mm	76mm
LFO4010	1 1/2"	x	10"	45mm	82mm
LFO5010	2"	x	10"	58mm	98mm
LFO5015	2"	x	15"	58mm	98mm
LFO809	3"	x	9"	86mm	128mm
LFO848	4"	x	8"	110mm	168mm

PRICES DO NOT INCLUDE 'GST' AND MAY BE SUBJECT TO CHANGE WITHOUT NOTICE



Irrigation  
direct.com.au

# ***STOCK TROUGH VALVES***



CODE | SIZE"

# STOCKMASTER

FLOAT VALVES FOR STOCK TROUGHS

*FLOW LIKE NEVER BEFORE (Above 15 psi)*

- ✓ COMPACT, HEAVY DUTY BRASS AND STAINLESS STEEL CONSTRUCTION
- ✓ NON RESTRICTING FULL FLOW
- ✓ OPERATES AT FULL FLOW THROUGH THE TOTAL OPERATING CYCLE
- ✓ MULTI-POSITIONAL ACTUATOR FOR COMPACT INSTALLATION
- ✓ PRESSURE RATING: Min. 1 psi (2.3 ft hd) - Max. Tested to 125 psi (288 ft hd)

Note: Minimum Flow required for operation (per valve in series)

MV25 = 70 l/min. MV 32 & MV40 = 120 L/min.



**Spray Guard available with all versions.**

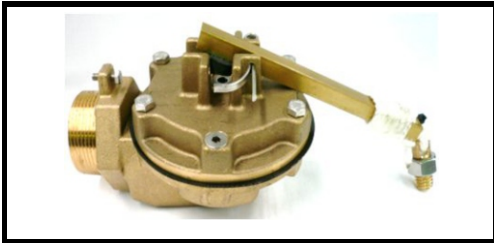

*Fitted in the wall of the trough below the water level.*

Ball Size
-----------

MV25	1	7"
MV32	1 1/4"	7"
MV40	1 1/2"	7"

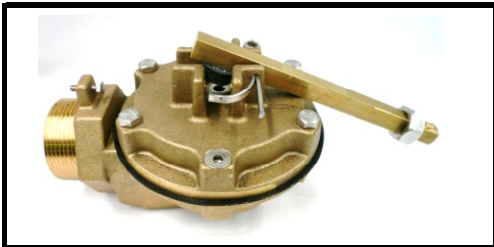

*Fitted in the wall at the top of the trough at water level under a sealed cover. Float Ball screws to end of arm.*

*Note: Spray Guard available if no cover used.*

Ball Size
-----------

MV25TF	1	7"
MV32TF	1 1/4"	7"
MV40TF	1 1/2"	7"

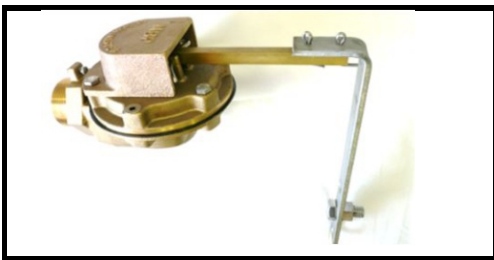

*Fitted over the top of the trough under a sealed cover. EXTENDED Stainless Arm with adjustable Float Ball position.*

**Note: Spray Guard fitted in this photo**

**\*\*ORDER IF REQUIRED**

Ball Size
-----------

MV25T	1	7"
MV32T	1 1/4"	7"
MV40T	1 1/2"	7"



*The diaphragm kit can be purchased by itself or with the*

*"stop-a-drip" washer which should be replaced at the same time*

FVS35  
FVS36

Diaphragm only  
Diaphragm & stop a drip washer

With arm facing forward:

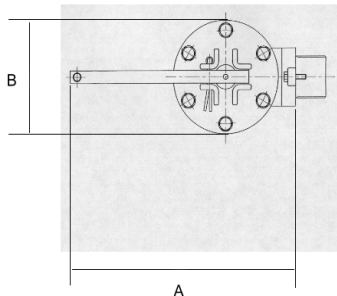

**DIMENSIONS**  
Not including float  
(TOP VIEW)

With arm to the side:

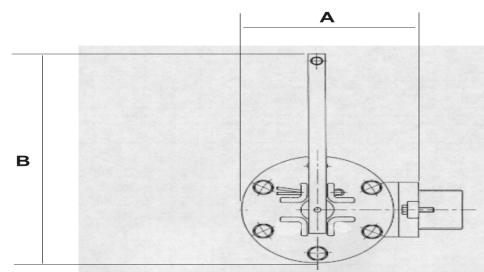

Size (mm)	25	32	40	50	80
(Imp)	1"	1 1/4"	1 1/2"	2"	3"
A	207	210	210	N/A	N/A
B	110	110	110	N/A	N/A

Size (mm)	25	32	40	50	80
(Imp)	1"	1 1/4"	1 1/2"	2"	3"
A	127	130	130	N/A	N/A
B	180	180	180	N/A	N/A

PRICES DO NOT INCLUDE 'GST' AND MAY BE SUBJECT TO CHANGE WITHOUT NOTICE

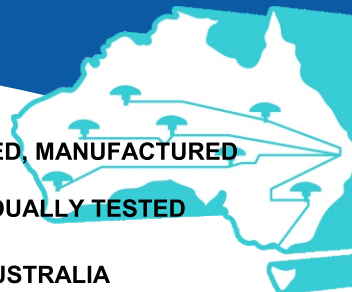

## HIGH PRESSURE

**VIRTUALLY STOCK PROOF *NOW* with STAINLESS STEEL Seat STANDARD !**

### HIGH PRESSURE FLOAT VALVES STAINLESS SEAT AND ARM WITH ADJUSTABLE BALL POSITION.

*This version of the HP valve has three fixing positions for the float on the stainless arm giving a water level variation of approx 70mm. Extra adjustment can be achieved by bending the arm.*

\* Reduced Bore

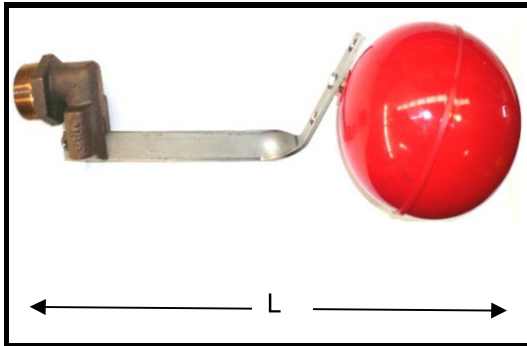

PLEASE NOMINATE BALL SIZE		Ball Size	L (mm)
HP20TSS	3/4"	6" Standard	470
HP25TSS	1"	6" Standard	470
<b>HPHF25TSS</b>	<b>1" 40% more flow</b>	<b>7"</b>	480
HP32TSS	1 1/4"	7" Standard	485
HP32TSS9	1 1/4"	9"	535
HP40TSS	1 1/2"	7" Standard	485
HP40TSS9	1 1/2"	9"	535
HP50TSS	2"	9"	550

### MEDIUM PRESSURE WITH 180MM SHORT ARM

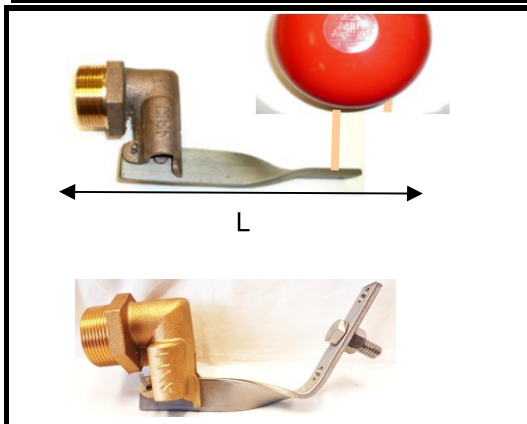

*This version of the popular and reliable MBP HP Float Valve is compact and has a medium pressure rating.*

		Ball Size	L (mm)
HP20CSS180	3/4"	7"	290
HP25CSS180	1"	7"	290
HP32CSS180	1 1/4"	7"	295
HP40CSS180	1 1/2"	9"	295
<b>180MM SHORT ARM ADJUSTABLE BALL POSITION</b>			
HP25TSS180	1"	7"	290
HP40TSS180	1 1/2"	9"	295

### HIGH PRESSURE FLOAT VALVES STAINLESS SEAT AND ARM WITH CORD / BALL ASSEMBLY.

*These High Pressure valves are extremely reliable and are now available with **stainless seats offering longer life with aggressive water.** Comes with Stainless Steel arm giving superior strength.*

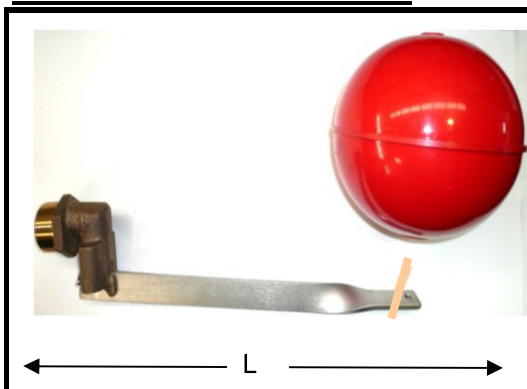

PLEASE NOMINATE BALL SIZE		Ball Size	L (mm)
HP20CSS	3/4"	6" Standard	430
HP25CSS	1"	6" Standard	430
<b>HPHF25CSS</b>	<b>1" 40% more flow</b>	<b>7"</b>	480
HP32CSS	1 1/4"	7" Standard	445
HP32CSS9	1 1/4"	9"	465
HP40CSS	1 1/2"	7" Standard	490
HP50CSS	2"	9"	550

**FLOAT VALVE SPARES SEE PAGES 24 & 25**

PRICES DO NOT INCLUDE 'GST' AND MAY BE SUBJECT TO CHANGE WITHOUT NOTICE





ROUDLY DESIGNED, MANUFACTURED  
AND INDIVIDUALLY TESTED  
IN AUSTRALIA



## HIGH PRESSURE

### HEAVY DUTY HIGH PRESSURE WITH BRASS THREADED ADJUSTABLE ARM

(FULL FLOW WITH 316 STAINLESS STEEL REDUCING INSERT)

*This version of the MBP Full Flow valve now has a 316 stainless insert to reduce the bore which converts it to high pressure. It features the same threaded adjustable arm as found on the Full Flow.*

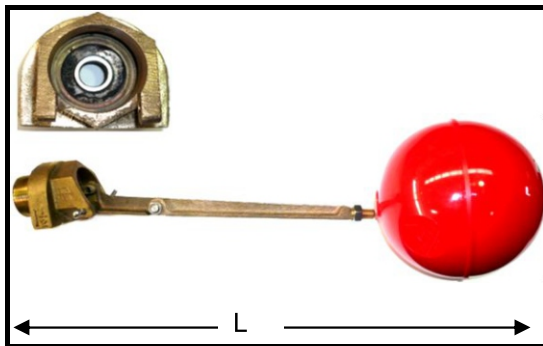

		Ball Size	L (mm)
HP25TA	1"	7"	520
HP32TA	1 1/4"	7"	540
HP40TA	1 1/2"	7"	535
HP50TA	2"	9"	580

### HEAVY DUTY HIGH PRESSURE-STAINLESS STEEL ARM and CORD.

(FULL FLOW WITH 316 STAINLESS STEEL REDUCING INSERT)

*Flow valve now has a 316 stainless insert to reduce the bore which converts it to high pressure. The robust features of the heavier Full Flow valve are thus retained.*

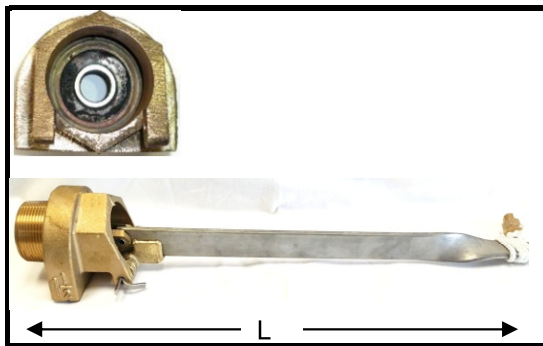

		Ball Size	L (mm)
HP25C	1"	7"	505
HP32C	1 1/4"	7"	515
HP40C	1 1/2"	7"	540
HP50C	2"	9"	560

### FLOAT VALVE BRASS REDUCING BUSH



*Brass Reducing Bush - 2" BSP Male x 1 1/2" BSP Female thread  
Use with 1 1/2" Stockmaster and other 1 1/2" Float Valves  
when fitting to 2" Inlet Sockets.*

RBB3225	1 1/4" x 1"	Reducing Bush
RBB5040	2" X 1 1/2"	Reducing Bush

PRICES DO NOT INCLUDE 'GST' AND MAY BE SUBJECT TO CHANGE WITHOUT NOTICE



PROUDLY DESIGNED, MANUFACTURED  
AND INDIVIDUALLY TESTED  
IN AUSTRALIA

## FULL FLOW (LOW PRESSURE)

**FULL FLOW FLOAT VALVES-CORD**  
**LOW PRESSURE WITH STAINLESS SEAT**  
**FULL FLOW (L.P.) CORD ASSEMBLIES COMPLETE**  
**CHAIN AVAILABLE AS AN OPTION**

*One of the most popular and reliable low pressure valves on the market now has stainless steel seats offering longer life with aggressive water. This Valve has a true full bore offering maximum flow.*

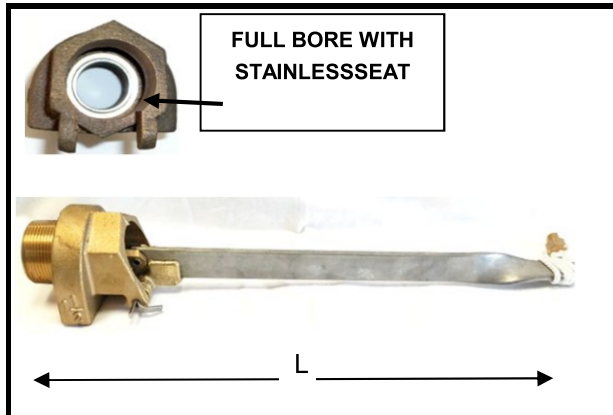

PLEASE NOMINATE BALL SIZE		Ball Size	L (mm)
FF25CSS	1"	7" Standard	520
FF25CSS9	1"	9"	535
FF32CSS	1 1/4"	7" Standard	540
FF32CSS9	1 1/4"	9"	565
FF40CSS	1 1/2"	7" Standard	555
FF40CSS9	1 1/2"	9"	560
FF50CSS	2"	9" Standard	580

## FULL FLOW WITH THREADED ADJUSTABLE ARM AND STAINLESS STEEL SEAT

**FULL FLOW (L.P.) THREADED ADJUSTABLE ARM**  
**ASSEMBLIES COMPLETE**

PLEASE NOMINATE BALL SIZE		Ball Size	L (mm)
FF25T	1"	7" Standard	520
FF32T	1 1/4"	7" Standard	540
FF32T9	1 1/4"	9"	565
FF40T	1 1/2"	7" Standard	555
FF40T9	1 1/2"	9"	560
FF50T	2"	9" Standard	580

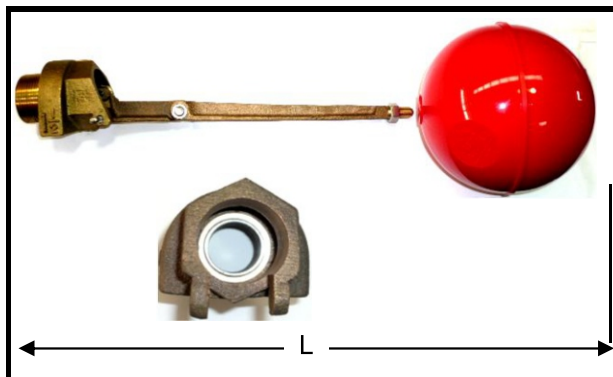

*This version of the MBP Full Flow valve features full threaded arm adjustment in two sections as shown. This makes it ideal for troughs with over the top entry.*

***One of the most popular and reliable low pressure valves on the market now has stainless steel seats offering longer life. This Valve has a true full bore providing maximum flow.***

PRICES DO NOT INCLUDE 'GST' AND MAY BE SUBJECT TO CHANGE WITHOUT NOTICE

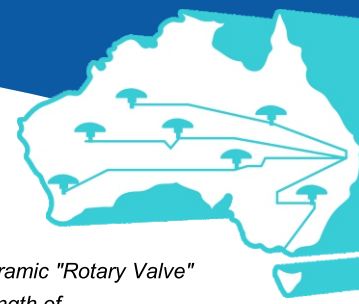

## MINI FLOAT VALVE



This Float Valve features a patented self cleaning Ceramic "Rotary Valve" seat enabling a compact design with a total overall length of 25cm (10"). Max. Operating Pressures 1/2" = 110psi, 3/4" & 1" = 90psi  
**NOTE:** Use in clean water applications recommended.

**L (mm)**

MPV15T	1/2"	Incl. 4" Ball	210
MPV20T	3/4"	Incl. 6" Ball	240
MPV25T	1"	Incl. 6" Ball	240

## BRASS FLOAT VALVE ASSEMBLIES

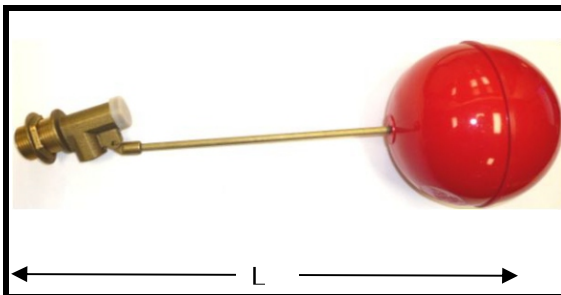

These are a budget type brass float valve complete with 6" ball and cord adaptor. They are not heavy duty but are quite reliable in the correct installation. Some spare parts are available.

**L (mm)**

HPV15T4	1/2"	Incl. 4" Ball	420
HPV15T6	1/2"	Incl. 6" Ball	420
HPV25C	1"	Incl. 6" Ball	460

## MEDIUM-HIGH PRESSURE FLOAT VALVES

(IMPORTED TYPES)

ABS (BLACK POLY.) FLOAT VALVE ASSEMBLIES

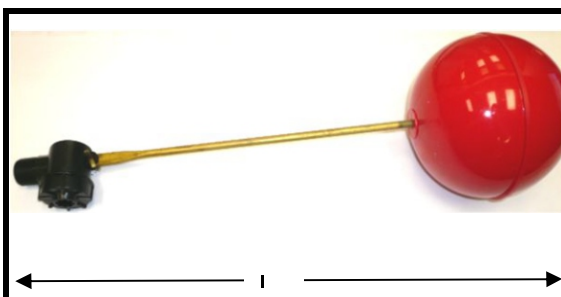

These imported valves are a good quality, low cost plastic valve and cord adaptor.  
 Ideal for aggressive water and in the top of tanks.



**L (mm)**

HPPVC20C	3/4"	** Does not include 6" Ball	545
----------	------	-----------------------------	-----

**SPARE PARTS FOR M.B.P. FLOAT VALVES**

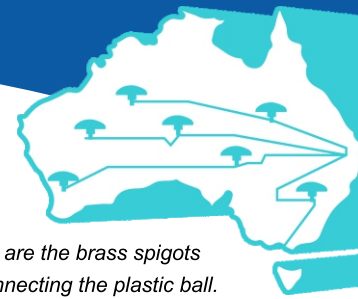

**PLASTIC BALL FLOATS**



- B6S            6"
- B7S            7"
- B9S            9"

**STAINLESS STEEL SPLIT PINS**



- 18SP02        For H.P. 3/4", 1", 1 1/4", 1 1/2"
- 18SP03        For 1" Full Flow
- 18SP04        For 1 1/4" Full Flow
- 18SP05        For 1 1/2", 2" Full Flow

**CORD & SPIGOTS / BRASS JACK CHAIN / CORD**



5/16" whitworth spigot suits  
4" & 6" balls.  
  
1/2" whitworth spigot suits  
7" & 9" balls.

- FVS24        Cord with 5/16" Brass Spigot
- FVS25        Cord with 1/2" Brass Spigot
- FVSCHAIN516 Chain with 5/16" Brass Spigot
- FVSCHAIN12 Chain with 1/2" Brass Spigot
- FVS27A       3mm (HP) Polyprop. Cord 1Mt.
- FVS27        4mm (LP) Polyprop. Cord 1 Mt.
- FVS27B       Heavy Duty Jack Chain 1 Mt.

**LONG SECTION END THREADED ADJ. ARM**



FVS12A is for 6" Ball  
FVS12B is for 7" Ball

- FVS12A       FF/LP Long Sect. 5/16" Arm
- FVS12B       FF/LP Long Sect. 1/2" Arm

**BRASS SPIGOTS ONLY**



These are the brass spigots for connecting the plastic ball. The cord is not included here. See below left for spigot with cord.

- 18SPIGOT516 5/16" W Brass Spigot
- 18SPIGOT12 1/2" W Brass Spigot
- 18SPIGOTCH 1/2" W Brass Spigot for Chain

**3/8" STAINLESS STEEL NUT AND BOLT FOR FULL FLOW THREADED ADJUSTABLE ARMS**



For LP/FF valves with threaded adjustable arms. Suits FF25T - FF50T.

- 18BOLT3/8X1 3/8" W x 1" Stainless Steel Bolt
- 18NUT3/8 3/8" W Stainless Steel Nut

**RUBBER PISTON WASHERS (SEALS)**



- SAD15        For 3/4", 1", 1 1/4" High Press.
- 18W075       For 1 1/2" High Pressure
- 18W100       For 1" Full Flow (LP)
- 18W125       For 1 1/4" Full Flow (LP)
- 18W150       For 1 1/2" Full Flow (LP)
- 18W200       For 2" Full Flow (LP)

**BLACK POLY CABLE TIES FOR CORD**



- 18CABLETIE

**SPARE PARTS FOR M.B.P. FLOAT VALVES**



**HIGH PRESSURE STAINLESS STEEL ARM  
INCLUDES PISTON, WASHER, CORD & SPIGOT**

*Interchangeable with old brass arm model*



FVS20CSS	3/4"	5/16 Spigot
FVS25CSS	1"	5/16 Spigot
FVS32CSS	1 1/4"	1/2" Spigot
FVS40CSS	1 1/2"	1/2" Spigot

*This is arm, piston, washer and the cord and spigot.*

*Suits HP20(SS)\*C - HP40(SS)\*C.*

**HIGH PRESSURE STAINLESS STEEL ARM  
(TO SUIT CORD) INCLUDES PISTON & WASHER.**

*Interchangeable with old brass arm model*



FVS20SS	3/4"
FVS25SS	1"
FVS32SS	1 1/4"
FVS40SS	1 1/2"

*This is arm, piston and washer only.*

**The cord and spigot are not included.**

*Suits HP20(SS)\*C - HP40(SS)\*C.*

**HIGH PRESSURE STAINLESS STEEL ARM 180mm  
INCLUDES PISTON, WASHER, CORD & SPIGOT**

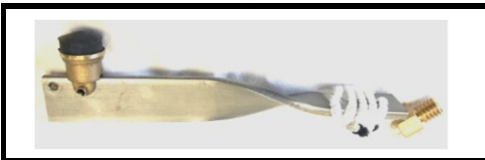

FVS25CSS180	1"	5/16" Spigot
FVSC32SS180	1 1/4"	1/2" Spigot
FVSC40SS180	1 1/2"	1/2" Spigot

*This is arm, piston, washer, cord & spigot - Suits HP..SS1800*

**HIGH PRESSURE STAINLESS STEEL ADJUSTABLE ARM 180mm  
INCLUDES PISTON, WASHER, BOLT & NUT**



FVS25TSS180	1"	1/2" Bolt
FVS40TSS180	1 1/2"	1/2" Bolt

*This is arm, piston, washer bolt & nut - Suits HP25TSS1800*

**FULL FLOW (LP) THREADED ADJUSTABLE ARM,  
INCLUDES PISTON, WASHER, BOLT & NUT**



FVSFF25T	1"	1/2" Thread
FVSFF32T	1 1/4"	1/2" Thread
FVSFF40T	1 1/2"	1/2" Thread
FVSFF50T	2"	1/2" Thread

*This is a threaded adjustable arm with piston & washer.  
For LP/FF valves only. Suits FF25T - FF50T.*

**FULL FLOW STAINLESS STEEL ARM  
INCLUDES PISTON, WASHER, CORD & SPIGOT**

*Interchangeable with old brass arm model*



FVSFF25CSS	1"	1/2" Spigot
FVSFF32CSS	1 1/4"	1/2" Spigot
FVSFF40CSS	1 1/2"	1/2" Spigot
FVSFF50CSS	2"	1/2" Spigot

*This is arm, piston, washer, cord & spigot - Suits FF..CSS*

# MBP AUSTRALASIA FLOAT VALVE FLOW CHARTS

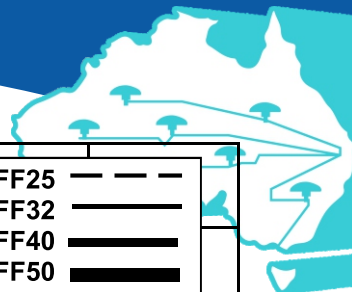

## FLOW RATES "LP" SERIES FULL FLOW FLOAT VALVES

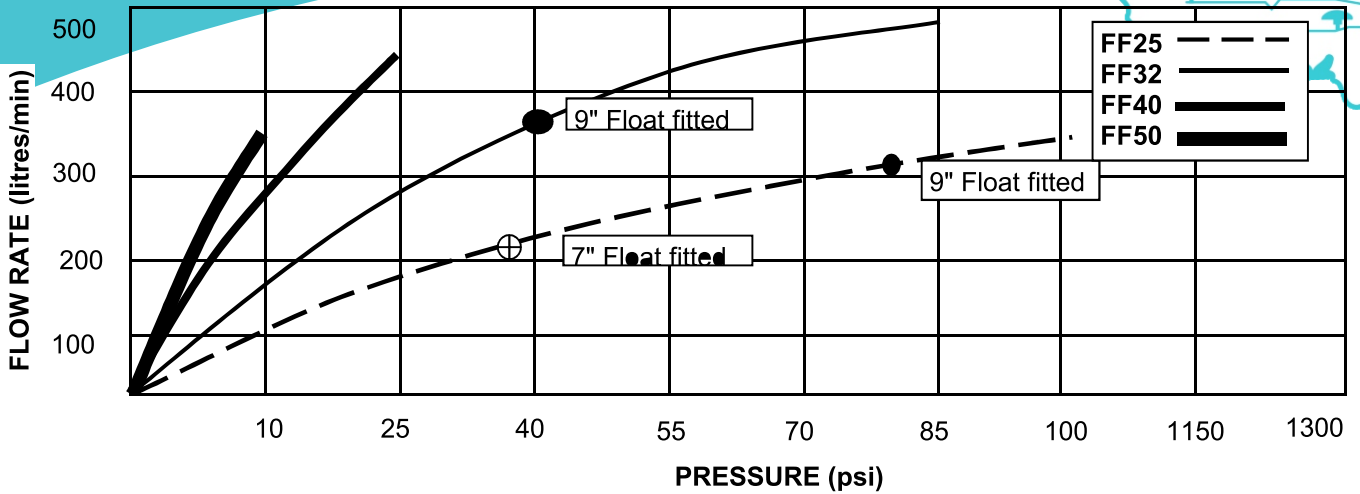

## FLOW RATES "HP" SERIES HIGH PRESSURE FLOAT VALVES

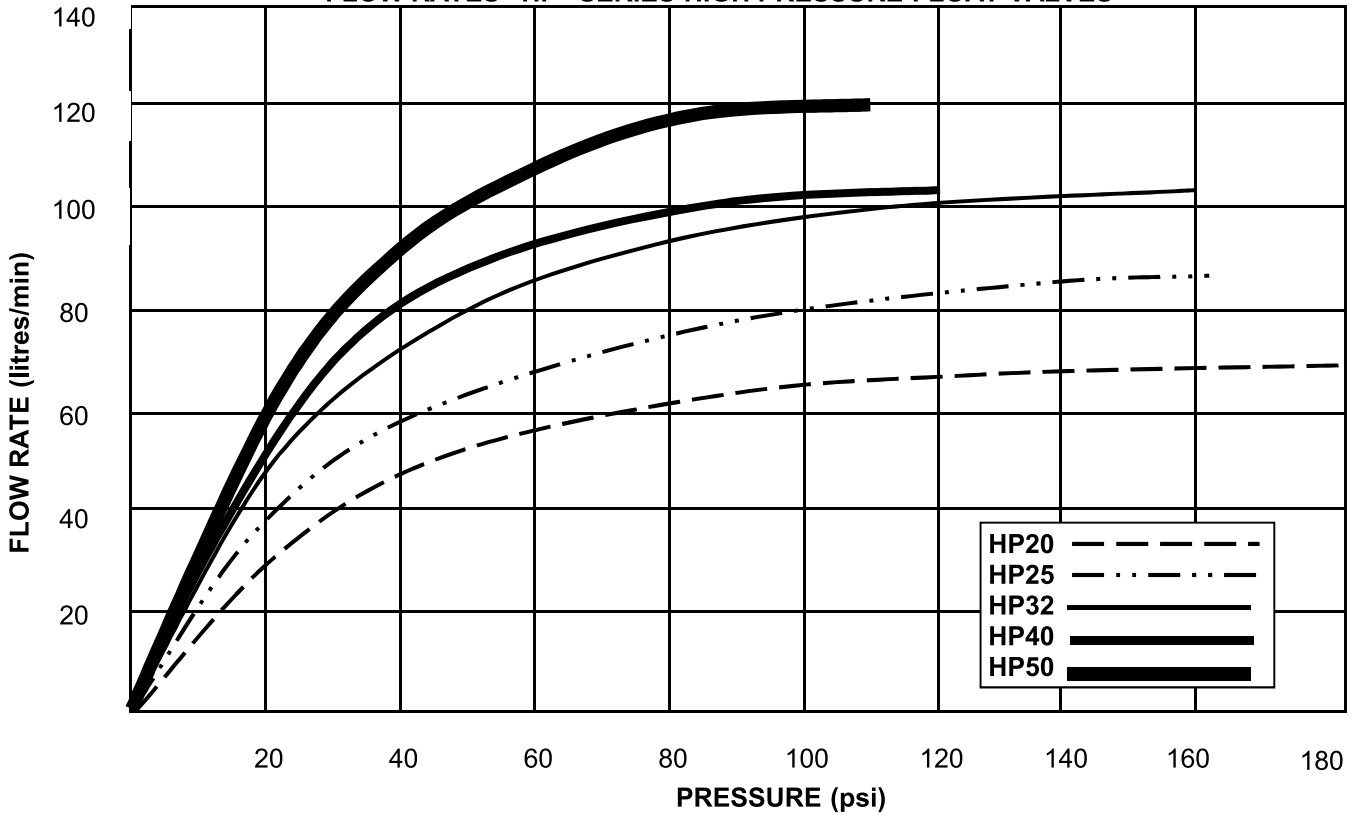

## FLOW RATE of STOCKMASTER 1 1/2" FLOAT VALVE - ( MV40 )

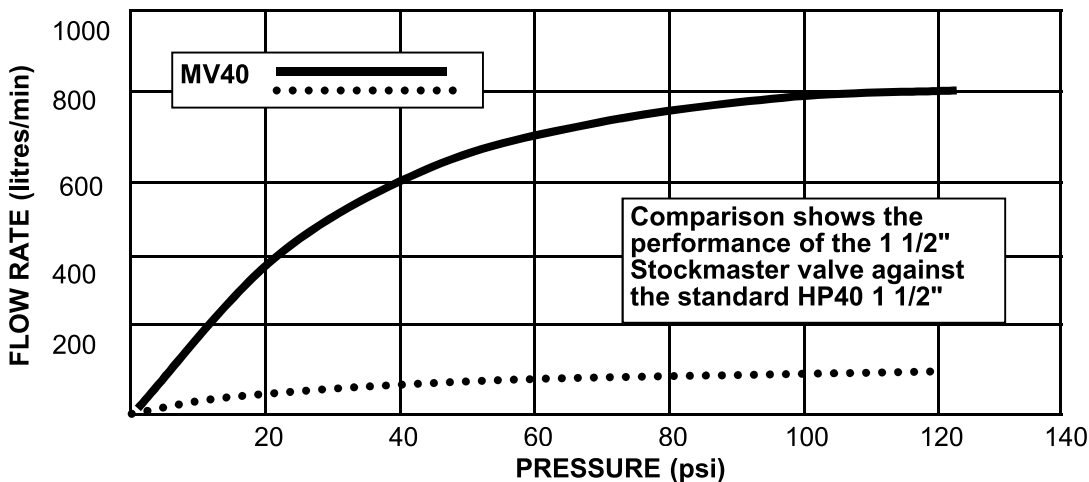

Flow rates shown are approximate and for pressure/flow at valve inlet. No allowance has been made for pipe friction loss.



### 3. FLOAT VALVES

#### • RAINDROP GLASS FILLED NYLON (Lead Free)

Low Pressure Valves 1" & 1¼" Rated to 30 PSI (with 6" ball oat)

Low Pressure Valves 1½" Rated to 15 PSI & 2" Rated to 12 PSI (with 7" ball oat)

High Pressure Valves ¾" – 1¼" Rated to 60 PSI (with 6" ball float) 1½" – 2" Rated to 60 PSI (with 7" ball float)

GFN VALVES BARE – No S/Stl Arm, No Float

Code	Size & Item Description
GFN075NF	¾" Universal - Bare Valve Only
GFN100LNF	1" LP - Bare Valve Only
GFN100HNF	1" HP - Bare Valve Only
GFN125LNF	1¼" LP - Bare Valve Only
GFN125HNF	1¼" HP - Bare Valve Only
GFN150LNF	1½" LP - Bare Valve Only
GFN150HNF	1½" HP - Bare Valve Only
GFN200LNF	2" LP - Bare Valve Only
GFN200HNF	2" HP - Bare Valve Only



DIRECT SCREWED TO BLACK PE BALL FLOATS (S/Stl. ARMS)

Code	Size & Item Description
GFN075BF	¾" Universal - 5" Arm & 6" Float
GFN100LBF	1" LP - c/w 5" Arm & 6" Float
GFN100HBF	1" HP - c/w 5" Arm & 6" Float
GFN125LBF	1¼" LP - c/w 5" Arm & 6" Float
GFN125HBF	1¼" HP - c/w 5" Arm & 6" Float
GFN150LBF	1½" LP - c/w 7" Arm & 7" Float
GFN150HBF	1½" HP - c/w 7" Arm & 7" Float
GFN200LBF	2" LP - c/w 7" Arm & 7" Float
GFN200HBF	2" HP - c/w 7" Arm & 7" Float



BULLET & SPLIT PIN (BSPin) WITH POLYSTYRENE FLOATS (S/Stl. ARMS)

Code	Size & Item Description
GFN075PF	¾" Universal – BSPin, 5" Arm & 10" Float
GFN100LPF	1" LP - c/w BSPin, 5" Arm & 10" Float
GFN100HPF	1" HP - c/w BSPin, 5" Arm & 10" Float
GFN125LPF	1¼" LP - c/w BSPin, 5" Arm & 10" Float
GFN125HPF	1¼" HP - c/w BSPin, 5" Arm & 10" Float
GFN150LPF	1½" LP - c/w BSPin, 7" Arm & 14" Float
GFN150HPF	1½" HP - c/w BSPin, 7" Arm & 14" Float
GFN200LPF	2" LP - c/w BSPin, 7" Arm & 14" Float
GFN200HPF	2" HP - c/w BSPin, 7" Arm & 14" Float



UNDERWATER APPLICATION c/w S/S Chain, Split Rings, S/Stl. Arms) & PE Ball Float

Code	Size & Item Description
GFN075UW	¾" Universal – S/SCh, Rings 5" Arm & 6" Flt
GFN100LUW	1" LP - S/S Chain, Rings, 5" Arm & 6" Float
GFN100HUW	1" HP - S/S Chain, Rings, 5" Arm & 6" Float
GFN125LUW	1¼" LP - S/S Chain, Rings, 5" Arm & 6" Float
GFN125HUW	1¼" HP - S/S Chain, Rings, 5" Arm & 6" Flt
GFN150LUW	1½" LP - S/S Chain, Rings, 7" Arm & 7" Float
GFN150HUW	1½" HP - S/S Chain, Rings, 7" Arm & 7" Flt
GFN200LUW	2" LP - S/S Chain, Rings, 7" Arm & 7" Float
GFN200HUW	2" HP - S/S Chain, Rings, 7" Arm & 7" Float



GFN Float Valve Spare Parts – Next Page



## • GFN FLOAT VALVE SPARES

Code	WHITE POLYSTYRENE FLOATS WITH SADDLE
PFS	SMALL – 10" Long (To suit ¾", 1" & 1¼")
PFM	MEDIUM – 14" Long (To suit 1½" & 2" valves)

Code	BALL FLOATS
PBF738	7" x 3/8" Thread
PBF6516	6" x 5/16" Thread
PFOVAL4	4" x 5/16" Thread – Oval Black Float – Cold water

Code	GFN FLOAT VALVE SPARES
GFNVFS	VALVE FLAP c/w Urethane Face (suit ¾", 1", 1¼")*
GFNVFL	VALVE FLAP c/w Urethane Face (suit 1½" & 2")*
GFNTS	BLACK PLASTIC 'T'- ARM (suit ¾", 1", 1¼")
GFNTL	BLACK PLASTIC 'T'- ARM (suit 1½" & 2")
SSPL	LARGE S/STL SPLIT PIN (2½" x 3/16" Dia)
SSPS	SMALL S/STL SPLIT PIN (2" x 3/16" Dia)
SSABN	S/STL ADJUSTING BOLT & NUT
SSA5LN	5" S/Stl Arm STD Direct Screwed to BF c/w Lock Nut UNF x ½" Whit (suit 1" & 1¼")
SSA7LN	7" S/Stl Arm STD Direct Screwed to BF c/w Lock Nut UNF x ½" Whit (suit 1½" & 2")
SSA5FTBS	5" S/Stl Arm UW c/w Bullet & Split Pin (suit ¾", 1", 1¼")
SSA7FTBS	7" S/Stl Arm UW c/w Bullet & Split Pin (suit 1½" & 2")
BSPINSS	S/Stl Bullet Only c/w Split Pin





## • RAINDROP ALUMINIUM BRONZE

5 YEAR WARRANTY AGAINST CORROSION

Low Pressure Valves 1" & 1¼" (fitted with 7" Ball)	Rated to 30 Psi
Low Pressure Valves 1" & 1¼" (fitted with 9" Ball)*	Rated to 80 Psi
Low Pressure Valves 1½" (fitted with 9" Ball)	Rated to 15 Psi
Low Pressure Valves 2" (fitted with 9" Ball)	Rated to 12 Psi
High Pressure Valves 1" & 1¼" (fitted with 7" Ball)	Rated to 60 Psi
High Pressure Valves 1" & 1¼" (fitted with 9" Ball)*	Rated to 90 Psi
High Pressure Valves 1½" & 2" (fitted with 9" Ball)	Rated to 60 Psi

CODE	ITEM DESCRIPTION
Ali/Bronze Float Valves c/w Brass Arm, Lock Nut & Black Poly Float (Direct Screwed)	
AB100LBF	1" LP c/w 3" Arm & 7" Float
AB100HBF	1" HP c/w 3" Arm & 7" Float
AB125LBF	1¼" LP c/w 3" Arm & 7" Float
AB125HBF	1¼" HP c/w 3" Arm & 7" Float
AB150LBF	1½" LP c/w 12" Arm & 9" Float
AB150HBF	1½" HP c/w 12" Arm & 9" Float
AB200LBF	2" LP c/w 12" Arm & 9" Float
AB200HBF	2" HP c/w 12" Arm & 9" Float
Ali/Bronze Float Valves c/w Brass Arm, Bullet & Split Pin & White Styrene Float	
AB100LSF	1" LP c/w 5" Arm & 10" Float
AB100HSF	1" HP c/w 5" Arm & 10" Float
AB125LSF	1¼" LP c/w 5" Arm & 10" Float
AB125HSF	1¼" HP c/w 5" Arm & 10" Float
AB150LSF	1½" LP c/w 9" Arm & 14" Float
AB150HSF	1½" HP c/w 9" Arm & 14" Float
AB200LSF	2" LP c/w 9" Arm & 14" Float
AB200HSF	2" HP c/w 9" Arm & 14" Float
Ali/Bronze Float Valves for Underwater Application c/w 2" Brass chain off arm, S/St. Chain & *Split rings & Black Poly Ball Float	
AB100LUW	1" LP c/w 5" Arm & 7" Float
AB100HUW	1" HP c/w 5" Arm & 7" Float
AB125LUW	1¼" LP c/w 5" Arm & 7" Float
AB125HUW	1¼" HP c/w 5" Arm & 7" Float
AB150LUW	1½" LP c/w 9" Arm & 9" Float
AB150HUW	1½" HP c/w 9" Arm & 9" Float
AB200LUW	2" LP c/w 9" Arm & 9" Float
AB200HUW	2" HP c/w 9" Arm & 9" Float
Ali/Bronze Float Valves (Bare) No Arm, No Ball Float	
AB100LNF	1" LP – No Arm & No Float
AB100HNF	1" HP – No Arm & No Float
AB125LNF	1¼" LP – No Arm & No Float
AB125HNF	1¼" HP – No Arm & No Float
AB150LNF	1½" LP – No Arm & No Float
AB150HNF	1½" HP – No Arm & No Float
AB200LNF	2" LP – No Arm & No Float
AB200HNF	2" HP – No Arm & No Float



Ali/Bronze Spare Parts on Page 12 of 136



## • RAINDROP 304 STAINLESS STEEL (Lead Free)

Low Pressure Valves 1" & 1¼" (fitted with 7" Ball)	Rated to 30 Psi
Low Pressure Valves 1" & 1¼" (fitted with 9" Ball)*	Rated to 80 Psi
Low Pressure Valves 1½" (fitted with 9" Ball)	Rated to 15 Psi
Low Pressure Valves 2" (fitted with 9" Ball)	Rated to 12 Psi
High Pressure Valves 1" & 1¼" (fitted with 7" Ball)	Rated to 60 Psi
High Pressure Valves 1" & 1¼" (fitted with 9" Ball)*	Rated to 90 Psi
High Pressure Valves 1½" & 2" (fitted with 9" Ball)	Rated to 60 Psi

CODE	ITEM DESCRIPTION
Stainless Steel Float Valves c/w St/Steel Arm, Lock nut & Black Poly Float (Direct Screwed)	
SS100LBF	1" LP c/w 3" Arm & 7" Float
SS100HBF	1" HP c/w 3" Arm & 7" Float
SS125LBF	1¼" LP c/w 3" Arm & 7" Float
SS125HBF	1¼" HP c/w 3" Arm & 7" Flt
SS150LBF	1½" LP c/w 12" Arm & 9" Float
SS150HBF	1½" HP c/w 12" Arm & 9" Float
SS200LBF	2" LP c/w 12" Arm & 9" Float
SS200HBF	2" HP c/w 12" Arm & 9" Float
Stainless Steel Float Valves c/w St/Steel Arm, Bullet & Split Pin & White Styrene Float	
SS100LSF	1" LP c/w 5" Arm & 10" Float
SS100HSF	1" HP c/w 5" Arm & 10" Float
SS125LSF	1¼" LP c/w 5" Arm & 10" Float
SS125HSF	1¼" HP c/w 5" Arm & 10" Float
SS150LSF	1½" LP c/w 9" Arm & 14" Float
SS150HSF	1½" HP c/w 9" Arm & 14" Float
SS200LSF	2" LP c/w 9" Arm & 14" Float
SS200HSF	2" HP c/w 9" Arm & 14" Float
Stainless Steel Valves for Underwater Application c/w 2" St/Steel chain off arm, S/St. Chain & *Split rings & Black Poly Ball Float	
SS100LUW	1" LP c/w 5" Arm & 7" Float
SS100HUW	1" HP c/w 5" Arm & 7" Float
SS125LUW	1¼" LP c/w 5" Arm & 7" Float
SS125HUW	1¼" HP c/w 5" Arm & 7" Float
SS150LUW	1½" LP c/w 9" Arm & 9" Float
SS150HUW	1½" HP c/w 9" Arm & 9" Float
SS200LUW	2" LP c/w 9" Arm & 9" Float
SS200HUW	2" HP c/w 9" Arm & 9" Float
Stainless Steel Float Valves (Bare) No Arm, No Ball Float	
SS100LNF	1" LP – No Arm & No Float
SS100HNF	1" HP – No Arm & No Float
SS125LNF	1¼" LP – No Arm & No Float
SS125HNF	1¼" HP – No Arm & No Float
SS150LNF	1½" LP – No Arm & No Float
SS150HNF	1½" HP – No Arm & No Float
SS200LNF	2" LP – No Arm & No Float
SS200HNF	2" HP – No Arm & No Float





• **RAINDROP 3” FLOAT VALVES – Stainless Steel and Bronze**

Spare parts available on request  
 Low Pressure (LP) Units Rated to 12 PS  
 High Pressure (HP) Units Rated to 60 PSI

CODE	ITEM DESCRIPTION
RFV3LP	3” LP Bronze Valve Bare c/w Arm Only – No Float
RFV3HP	3” HP Bronze Valve Bare c/w Arm Only – No Float
SSFV3LP	3” LP S/Steel Valve Bare c/w Arm Only – No Float
SSFV3HP	3” HP S/Steel Valve Bare c/w Arm Only – No Float
PFL	White Polystyrene Float c/w Saddle
PEFL	Black Polyethylene Float c/w Saddle
PFGCL	ZP Steel Cover Suit Polystyrene Float
SSFL	Stainless Steel Float c/w Saddle
RFVF3LPHP	Bronze Replacement Valve Flap c/w Rubber Suit 3” Vlv
SSRFVF3R	S/Stl Replacement Valve Flap c/w Rubber Suit 3” Vlv
SSFVR3	Replacement Rubber Suit Stainless Stl 3” Valve Only
RFVR3LP	Replacement Rubber Suit Bronze 3” Valve Only
RFVSBN	S/Steel Adjusting Bolt & Nut Suit 3” Valve



3” Raindrop Bronze Float Valve – Bare



3” Raindrop Stainless Steel Float Valve – Bare



Large Polystyrene Float



With ZP Steel Cover

• **COMET LOW PRESSURE BRASS FLOAT VALVE c/w BRASS FLOAT**

COD	ITEM DESCRIPTION
CFV3	3” LP (9 PSI) BSP Female
CFV4	4” LP (9 PSI) BSP Female

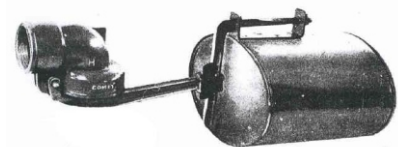

• **“BROWN” LAMBETH PATTERN HIGH PRESSURE FLOAT VALVE – No Longer Available**



## • RAINDROP ALI/BRONZE FLOAT VALVE SPARES

CODE	ITEM DESCRIPTION
A/BVFS	Ali/Bronze Valve Flap Small c/w Rubber (suits 1" & 1¼")
A/BVFL	Ali/Bronze Valve Flap Large c/w Rubber (suits 1½" & 2")
A/BVFRS	Ali/Bronze Valve Flap rubber only (suits 1" & 1¼")
A/BVFRLO	Ali/Bronze Valve Flap rubber only (suit 1½" & 2") – Old Type 61mm OD No hole in back of Ali/Bronze Flap
A/BVFRNL	Ali/Bronze Valve Flap rubber only (suit 1½" & 2")– New Type 70mm OD Hole in back of Ali/Bronze Flap
FVPI25L	Float Valve Plastic Insert Low Pressure to suit 1" valves
FVPI25H	Float Valve Plastic Insert High Pressure to suit 1" valves
FVPI32L	Float Valve Plastic Insert Low Pressure to suit 1¼" valves
FVPI32H	Float Valve Plastic Insert High Pressure to suit 1¼" valves
FVPI40L	Float Valve Plastic Insert Low Pressure to suit 1½" valves
FVPI40H	Float Valve Plastic Insert High Pressure to suit 1½" valves
FVPI50L	Float Valve Plastic Insert Low Pressure to suit 2" valves
FVPI50H	Float Valve Plastic Insert High Pressure to suit 2" valves
ABBATS	Ali/Bronze Brass T-Arm Small c/w pin (suits 1" & 1¼")
ABBATL	Ali/Bronze Brass T-Arm Large c/w pin (suits 1½" & 2")
BA3LN	3" Brass Arm STD c/w Lock nut – UNF x ½" Whit (suits 1" & 1¼")
BA5LN	5" Brass Arm STD c/w Lock nut – UNF x ½" Whit (suits 1" & 1¼")
BA7LN	7" Brass Arm STD c/w Lock nut – UNF x ½" Whit (suits 1½" & 2")
BA9LN	9" Brass Arm STD c/w Lock nut - UNF x ½" Whit (suits 1½" & 2")
BA12LN	12" Brass Arm STD c/w Lock nut – UNF x ½" Whit (suits 1½" & 2")
LN1/2	S/St ½" Whit Lock Nut
PBF7	7" Black Poly Ball Float only - ½" Whit Fem (suits 1" & 1¼")
PBF9	9" Black Poly Ball Float only - ½" Whit Fem (suits 1½" & 2")
PBF9US	9" Under size black Poly Ball Float only - ½" Whit Fem (suits 1½" & 2")

### ALI/BRONZE SPARE PARTS FOR UNDERWATER APPLICATION

COR2LN	2" Brass Chain off arm c/w ½"W Lock nut (suits 7" & 9" Ball Floats)
COR5	5" Brass Chain off arm Std. UNF x Hole end (suits 1" & 1¼")
COR7	7" Brass Chain off arm Std. UNF x Hole end (suits 1" & 1¼")
COR9	9" Brass Chain off arm Std. UNF x Hole end (suits 1½" & 2")
COR12	12" Brass Chain off arm Std. UNF x Hole end (suits 1½" & 2")
COR516	5/16" W Male Brass Chain-Off Adaptor
BA5FT	5" Brass Arm for Cap Off ends – UNF x UNF (suits 1" & 1¼")
BA7FT	7" Brass Arm for Cap Off ends – UNF x UNF (suits 1" & 1¼")
BA9FT	9" Brass Arm for Cap Off ends – UNF x UNF (suits 1½" & 2")
BA12FT	12" Brass Arm for Cap Off ends- UNF x UNF (suits 1½" & 2")
CAPOFF	Ali/Bronze Cap Off ends (UNF Fem) (suits 1"-2")
BSPIN	Brass Bullet & Split Pin
S/SSRING	Stainless steel Split rings 2 per Valve
DSH4	S/St. D Shackles 4 mm STD in lieu of Split rings
DSH4.7	S/St. D Shackles 4.7mm STD in lieu of Split rings
DSH6.4	S/St. D Shackles 6.4mm
S/SCH12	12" Length Stainless steel Chain
S/SCHM	1 Metre length stainless steel chain
CORD	2' length Marine Grade Cord
BCA5	Chain Assy. U/W operation c/w 5" & 2" Brass Arms, SS 12" chain & split rings (1 & 1¼" valves)*
BCA9	Chain Assy. U/W operation c/w 9" & 2" Brass Arms, SS 12" chain & split rings (1½" & 2" valves)*



## • RAINDROP STAINLESS STEEL FLOAT VALVE SPARES

CODE	ITEM DESCRIPTION
SSVFS	Stainless Stl Valve Flap Small c/w Rubber (suits 1" & 1¼")
SSVFL	Stainless Stl Valve Flap Large c/w Rubber (suits 1½" & 2")
SSVFRS	Stainless Stl Valve Flap Rubber Only (suits 1" & 1¼")
SSVFRL	S/Stl Valve Flap Rubber Only (suit 1½" & 2")– 70mm OD Hole in back of Metal Flap
FVPI25L	Float Valve Plastic Insert Low Pressure to suit 1" valves
FVPI25H	Float Valve Plastic Insert High Pressure to suit 1" valves
FVPI32L	Float Valve Plastic Insert Low Pressure to suit 1¼" valves
FVPI32H	Float Valve Plastic Insert High Pressure to suit 1¼" valves
FVPI40L	Float Valve Plastic Insert Low Pressure to suit 1½" valves
FVPI40H	Float Valve Plastic Insert High Pressure to suit 1½" valves
FVPI50L	Float Valve Plastic Insert Low Pressure to suit 2" valves
FVPI50H	Float Valve Plastic Insert High Pressure to suit 2" valves
SSATS	Stainless Stl T-Arm Small c/w Screw & Nut Set (suits 1" & 1¼")
SSATL	Stainless Stl T-Arm Large c/w Screw & Nut Set (suits 1½" & 2")
SSA3LN	3" Stainless Stl Arm STD c/w Lock nut – UNF x ½" Whit (suits 1" & 1¼")
SSA5LN	5" Stainless Stl Arm STD c/w Lock nut – UNF x ½" Whit (suits 1" & 1¼")
SSA7LN	7" Stainless Stl Arm STD c/w Lock nut – UNF x ½" Whit (suits 1½" & 2")
SSA9LN	9" Stainless Stl Arm STD c/w Lock nut - UNF x ½" Whit (suits 1½" & 2")
SSA12LN	12" Stainless Stl Arm STD c/w Lock nut – UNF x ½" Whit (suits 1½" & 2")
LN1/2	S/St ½" Whit Lock Nu
PBF7	7" Black Poly Ball Float only - ½" Whit Fem (suits 1" & 1¼")
PBF9	9" Black Poly Ball Float only - ½" Whit Fem (suits 1½" & 2")
PBF9US	9" Under size black Poly Ball Float only - ½" Whit Fem (suits 1½" & 2")

### STAINLESS/STL SPARE PARTS FOR UNDERWATER APPLICATION

SSCOR2LN	2" Stainless Stl Chain Off Arm c/w ½"W Lock nut (suit 7"/9"Ball Floats)
SSCOR5	5" Stainless Stl Chain Off Arm Std. UNF x Hole end (suits 1" & 1¼")
SSCOR7	7" Stainless Stl Chain Off Arm Std. UNF x Hole end (suits 1" & 1¼")
SSCOR9	9" Stainless Stl Chain Off Arm Std. UNF x Hole end (suits 1½" & 2")
SSCOR12	12" Stainless Stl Chain Off Arm Std. UNF x Hole end (suits 1½" & 2")
SSA5FT	5" Stainless Stl Arm for Cap Off Ends – UNF x UNF (suits 1" & 1¼")
SSA7FT	7" Stainless Stl Arm for Cap Off Ends – UNF x UNF (suits 1" & 1¼")
SSA9FT	9" Stainless Stl Arm for Cap Off Ends – UNF x UNF (suits 1½" & 2")
SSA12FT	12" Stainless Stl Arm for Cap Off Ends- UNF x UNF (suits 1½" & 2")
SSCAPOFF	Stainless Stl Cap Off Ends (UNF Fem) (suits 1"-2")
BSPINSS	Stainless Stl Bullet & Split Pin
S/SSRING	Stainless Steel Split Rings \$/Each – Need 2 per Valve
DSH4	S/St. D Shackles 4 mm STD in lieu of Split rings
DSH4.7	S/St. D Shackles 4.7mm STD in lieu of Split rings
DSH6.4	S/St. D Shackles 6.4mm
S/SCH12	12" Length Stainless steel Chain
S/SCHM	1 Metre length stainless steel chain
CORD	2' length Marine Grade Cord
SSCA5	Chain Assy. U/W operation c/w 5" & 2" S/Stl Arms, SS 12" chain & split rings (1 & 1¼" valves)*
SSCA9	Chain Assy. U/W operation c/w 9" & 2" S/Stl Arms, SS 12" chain & split rings (1½" & 2" valves)*



## • COPPER BALL FLOATS

CODE	DESCRIPTION
CBF3X5	3" x 5" Long Copper OVAL Float (5/16"W) – Silver Soldered
CBF412	4½" Copper B/Float (5/16"W) Silver Soldered – SAND WEIGHTED Tube type
CBF6	6" Copper Ball Float (5/16"W) Rubber Sealed Cold (60°C) Water Only
CBF6SS	6" Copper Ball Float (5/16"W) Silver Soldered (95°C) Water
	Following are Silver Soldered with Tube Through Centre for Strength:
CBF8	8" Copper Ball Float (½"W) Suit Hot (95°C) Water – Tube, Silver Soldered
CBF10	10" Copper Ball Float (½"W) Suit Hot (95°C) Water – Tube, Silver Soldered

Other Sizes of Copper Floats available on Request – POA (3", 4", 4½", 5", 7", 9" & 10")  
 316 Stainless Steel Round Floats Also Available – POA – (3", 4½", 5", 6", 7", 8" & 10")

## • FLOAT VALVE RUBBERS - SOUTHERN CROSS, COMET & MBP

Item Code		
<b>SOUTHERN CROSS FLOAT VALVE RUBBERS</b>		
FVR1SXHP or FVR1SXLP		
FVR114SXHP or FVR114SXLP		
FVR112SXHP or FVR112SXLP		
FVR2SXHP or FVR2SXLP		
FVR212SXLP		
FVR3SXLP		
FVR4SXLP		
<b>COMET FLOAT VALVE RUBBERS</b>		
FVR1CHP or FVR1CLP		
FVR114CHP or FVR114CLP		
FVR112CHP or FVR112CLP		
FVR2CHP or FVR2CLP		
FVR212CHP or FVR212CLP		
FVR3CLP		
FVR4CLP		
<b>MBP FLOAT VALVE RUBBERS (DOME SHAPED)</b>		
FVRMBP20HP - ¾" HP* (SAD15)		
FVRMBP25HP – 1" HP * (SAD15)		
FVRMBP25LP - 1" LP (18W100)		
FVRMBP32HP – 1¼" HP* (SAD15)		
FVRMBP32LP – 1¼" LP (18W125)		
FVRMBP40HP – 1½" HP (18W075)		
FVRMBP40LP – 1½" LP (18W150)		
FVRMBP50HP/LP - 2" HP & 2" LP are the same (18W200)		

## • SX 'J' CAST IRON CHECK VALVE LEATHERS (SET OF 2)

Leather Clack & Ring Washers – Sold as set of 2 Only	
CODE	SIZE
JB007/008	1¼"
JC007/008	1½"
JD007/008	2"





- MBP STOCKMASTER BRASS FLOAT VALVES**  
**c/w 7" Poly Ball Float (For Stocktroughs) Rated to 125 PSI (288 Ft Head)**

Minimum Flow Required for Operations (Per Valve In Series)

MV25 – 1" = 70 Litres Per Minute

MV32 & MV40 – 1 ¼" & 1 ½" = 120 Litres Per Minute

Three Types of Each Size Valves Available: V32 & MV40 – 1 ¼" & 1 ½" = 120 Litres Per Minute

CODE	DESCRIPTION
<b>Fitted In Wall of Trough Below Water Level – Underwater Operations</b>	
MBPMV25	MV25 - 1" Stockmaster Brass Float Valve c/w Cord, Spigot & 7" Plastic Ball Float for Underwater Operation
MBPMV32	MV32 - 1¼" Stockmaster Brass Float Valve c/w Cord, Spigot & 7" Plastic Ball for Underwater Operation
MBPMV40	MV40 - 1½" Stockmaster Brass Float Valve c/w Cord, Spigot & 7" Plastic Ball for Underwater Operation
<b>Top Entry – Direct Screwed Fixed Arm (TF)</b>	
MBPMV25T	MV25TF - 1" Stockmaster Brass Float Valve with Fixed Arm c/w 7" Plastic Ball Float
MBPMV32T	MV32T- 1¼" Stockmaster Brass Float Valve with Fixed Arm c/w 7" Plastic Ball Float
MBPMV40T	MV32T- 1¼" Stockmaster Brass Float Valve with Fixed Arm c/w 7" Plastic Ball Float
<b>Fitted Over Top Of Trough Above Water Level (T)</b>	
MBPMV25T	MV25T- 1" Stockmaster Brass Float Valve c/w Std Adjustable Arm & 7" Plastic Ball Float
MBPMV32T	MV32T- 1¼" Stockmaster Brass Float Valve c/w Std Adjustable Arm & 7" Plastic Ball Float
MBPMV40T	MV40T- 1½" Stockmaster Brass Float Valve c/w Std Adjustable Arm & 7" Plastic Ball Float
<b>Spray Guards (if required) Fit All Sizes of Valves At Additional Cost</b>	
MBPFVSMVSG	FVSMVSG SprayGuard Kit to suit Stockmaster Valves (Fits all Float Valve Sizes)
Repair Kit for Stockmaster Float Valves – Fits All Sizes	
MBPFVS35	FVS35 – Diaphragm
MBPFVS36	FVS36 – Diaphragm Repair Kit With Stop A-Drip Washer
MBPFVS38	MBPFVS38 S/Stl Extension Arm Only Suit 1½" Stockmaster Fit Valve MV40T



## • DIAPHRAGM HIGH PRESSURE FLOAT VALVES

Diaphragm Float Valves operate using both a diaphragm valve and pilot float valve.

The pilot float valve (5) is installed in the tank, trough or reservoir and regulates the diaphragm valve via a nylon or copper tube (i.e. 1/4") through the control chamber (2) above diaphragm.

The location of the pilot float valve assembly and the position of the float (4), (3) determine the level setting in the tank or reservoir.

The control valve (1) is adjusted to regulate the diaphragm opening & closing speed.

The assembly is usually installed with a ball valve (6) for manual closing.

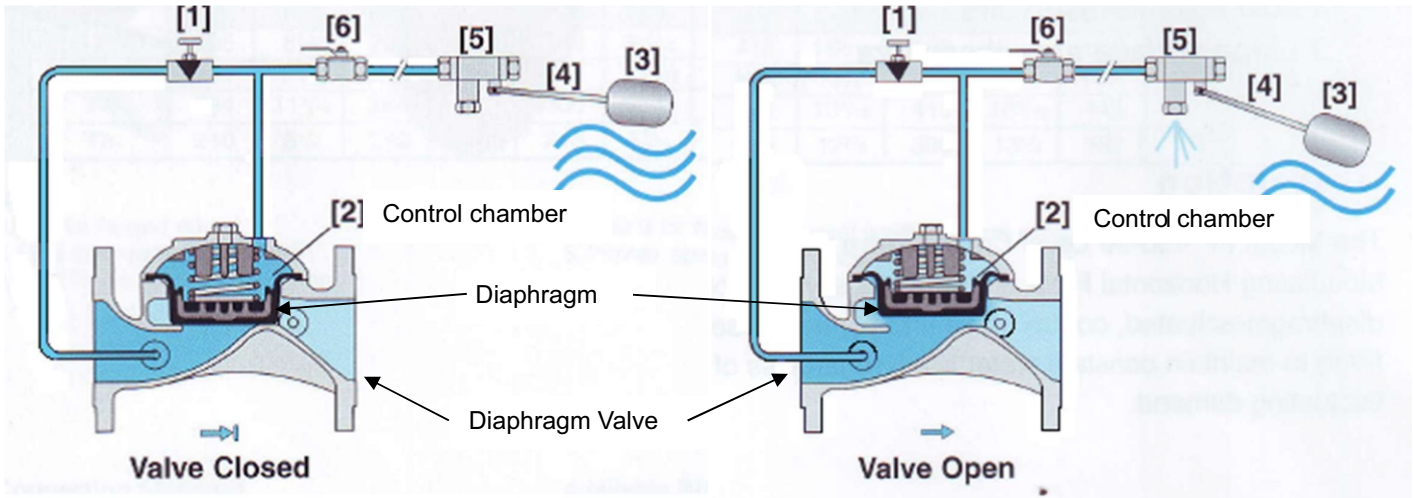

### Features include

- line pressure driven – independent operation
- no water hammer closing
- less wear & tear
- in line serviceable – easy maintenance in
- low opening pressure requirements (1.5 Bar) low
- very high flow capacityvery hi
- easy installation in inaccessible locations easy
- ideal for aggressive or corrosive fluids
- Pilot valve available in brass or Stainless Steel
- Diaphragm valve available in both **FBE coated ductile iron or poly**
- Sizes: 2", 2½", 3", 4", 6", 8", 10" & 12"
- Max. Pressure rating: 250Psi
- Temperature rating: up to 50°C
- Flanged and Threaded Diaphragm valves available

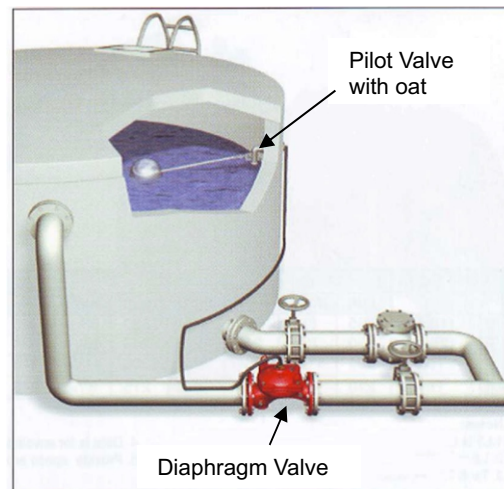

### DIAPHRAGM FLOAT VALVE c/w Pilot Float Valve & Float

- Diaphragm Valve: FBE Duplex Coated Ductile iron
- Brass Pilot Float Valve c/w Float
- Stainless Steel Needle valve
- Nylon high pressure tube
- Plated Brass ball valve for manual closing

Code	Description
FL-D-50	2" Flanged T'D' Diaphragm Float Valve
FL-D-80	3" Flanged T'D' Diaphragm Float Valve
FL-D-100	4" Flanged T'D' Diaphragm Float Valve
FL-D-150	6" Flanged T'D' Diaphragm Float Valve
FL-D-200	8" Flanged T'D' Diaphragm Float Valve
FL-D-250	10" Flanged T'D' Diaphragm Float Valve





• **APEX FULL FLOW RESERVOIR VALVES – Spare Parts On Page 23 of 136**

**APEX XTRAFLO TROUGH VALVES c/w Blue Float Short/Long Thread Optional on 3/4" & 1" Units**

NOTE: Rated to 175 Psi and requires min. 4 Psi at Valve entry to operate

Code & Size
XTF20 - 3/4"
XTF25 - 1"
XTF32 - 1 1/4"
XTF FLOAT
<b>TOP ENTRY VERSION c/w 4 1/2" Ball Float</b>
XTFTE20 - 3/4"
XTFTE25 - 1"
XTFTE32 - 1 1/4"



**APEX FULL FLOW RESERVOIR VALVE c/w 6" ORANGE BALL FLOAT**

Long or Short Brass Arm/Thread Options type available on 3/4" & 1" Units - Rated to 170 Psi

P20-15 - 1/2"
P20-20 - 3/4"
P20-25 - 1"
<b>SHORT ARM, LONG THREAD c/w back nut, washer &amp; 6" Fit Rated to 135 Psi</b>
P20-20SALT - 3/4"
P20-25SALT - 1"
<b>STANDARD – Rated to 80Psi (Option to increase to 120 Psi rating using Brass Twin Float Connector &amp; extra 6" Ball Float)</b>
P20-32 1 1/4"
P20-40 1 1/2"
P20-50 2"
<b>SPECIAL ASSEMBLY (c/w 9" U/S Ball float &amp; Brass Adaptor)</b>
P20-32BF9 1 1/4"
P20-40BF9 1 1/2"
P20-50BF9 2"

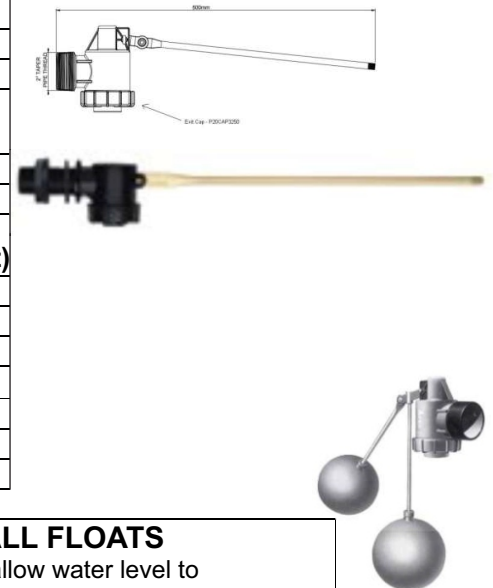

**APEX FULL FLOW 2 LEVEL FLOAT VALVE c/w 2 x 6" BALL FLOATS**

Quick Acting – rated to 800 l/min at 100 PSI. Valve is fully adjustable to allow water level to fall 65 & 270mm before opening – eliminates pump overload.

P21-32 1 1/4"
P21-40 1 1/2"
P21-50 2"

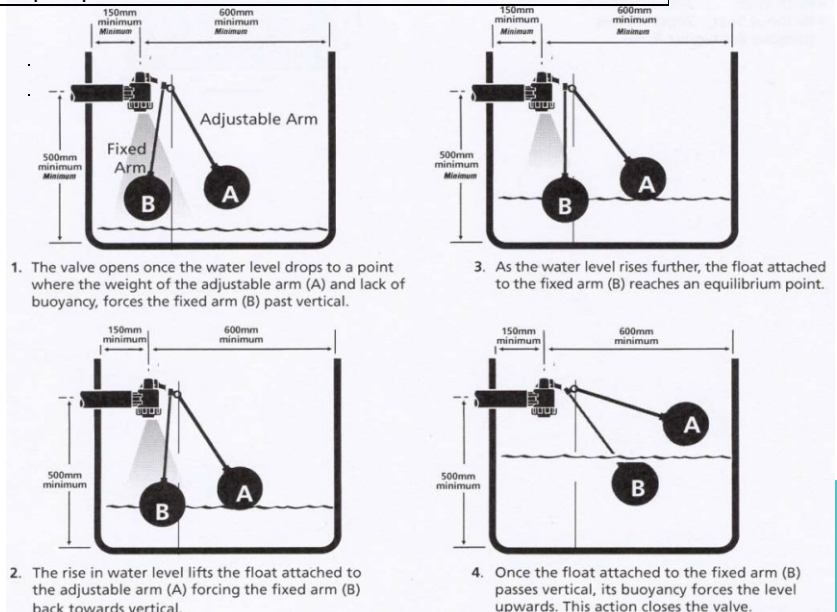
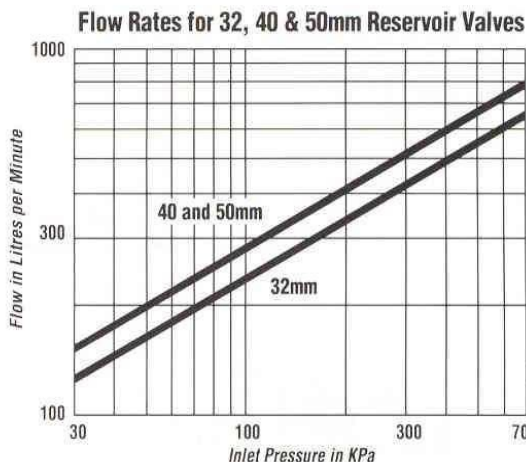



## APEX FLOAT VALVES CONT'D

### APEX BRASS FLOAT VALVES c/w 6" Ball Float (Rated to 150PSI) 60°C

Code & Size
A20-B20 - 3/4"
A20-B25 - 1"



### APEX HIGH FLOW PLASTIC FLT.VALVES c/w float. Rated to 120PSI, Plastic lever. Space Saver Valve with Float.

Code & Size
P15SS - 1/2"
P20SS - 3/4"
RKSS - Space Saver Repair Kit P15/20SS



### APEX FLOAT VALVE ACCESSORIES

Apex Float Valve Spare Parts on Page 23 & 24 of 136

Code	Description
APEX4BFLT	PFL Black 4" Ball Float (5/16" Fem)
APEX6BFLT	PFL Orange Ball Float 6" (5/16" Fem)
APEXXTF	XTF Blue Float
APEXCP	Apex Cord c/w Plastic End Fittings (5/16" M&F)
APEXCB	Apex Cord Fittings c/w 5/16"Whit M&F Brass End Fittings
APEXTFC	Twin float connector - Plastic
Ba1256	1/2"W MI x 5/16"W FI Brass Float Valve Adaptor c/w Serrated Lock Nut (P20Adaptor)



## TAIWAN BRASS & MBP

### TAIWAN BRASS FLOAT VALVES c/w Ball Float (Rated to 70 PSI)

Code & Size
A20-15 1/2" (4" Ball float)
A20-20 3/4" (6" Ball float)
A20-25 1" (6" Ball float)



### • MBP MINI FLOAT VALVES – Obsolete MPV Range



• **JOBE – MEGAFLOW, TOPAZ & ROJO VALVES (Diaphragm type)**

**MEGAFLOW FLOAT VALVES**

FULL FLOW: 140l/min @ 100KPa (14PSI), 200 l/min @ 200KPa (28PSI)  
 OPERATING PRESSURE: 35-950 KPa (5-135PSI) – UNDERWATER (SIDE OR BOTTOM ENTRY) INSTALLATION ONLY



CODE	DESCRIPTION
<b>Megaflow Float Valves Detach Type c/w Yellow Triangular Float</b>	
VJMF20	3/4" Megaflow Float Valve Std Thread
VJMF25	1" Megaflow Float Valve Std Thread
VJMF32	1 1/4" Megaow Float Valve Std Thread

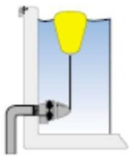

SIDE ENTRY

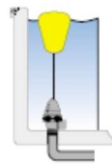

BOTTOM ENTRY

Add Code LT for Long Thread Units – P.O.A.

**TOPAZ FLOAT VALVES**

FULL FLOW: 140l/min @ 100KPa (14PSI), 200 l/min @ 200KPa (28PSI)  
 OPERATING PRESSURE: 35-950 KPa (5-135PSI)  
 TOP, SIDE OR BOTTOM ENTRY



CODE	DESCRIPTION
<b>Topaz Float Valves Detach Type c/w Yellow Ball Float</b>	
TPZ20	3/4" Topaz Float Valve c/w 4 1/2" Ball
TPZ25	1" Topaz Float Valve c/w 4 1/2" Ball
TPZ32	1 1/4" Topaz Float Valve c/w 4 1/2" Ball
TPZRK	Diaphragm Kit Suit Topaz Valves

**Mounting Positions**

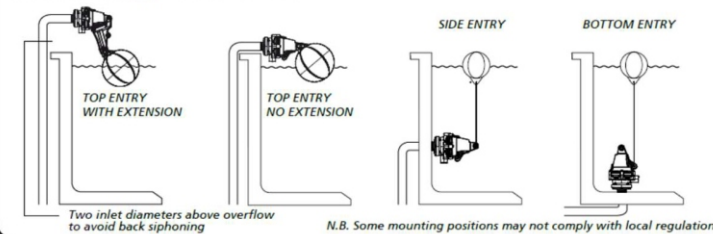

**JOBE ROJO FLOAT VALVES**

For use in small troughs/ restricted spaces with low flow requirements  
 LOW FLOW: will produce only 15-20 l/min  
 OPERATING PRESSURE: 35-950 KPa (5-135PSI)– TOP, SIDE OR BOTTOM ENTRY



CODE	DESCRIPTION
RJ15	1/2" Obsolete
RJ20	3/4" Rojo Float Valve c/w 4 1/2" Ball Float

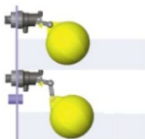

TOP ENTRY



SIDE ENTRY

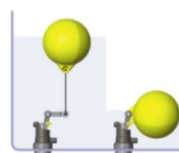

BOTTOM ENTRY



## • HANSEN FLOAT VALVES – SUPER FLO, MAX FLO, LEVELLER

### SUPER-FLO VALVE – PISTON TYPE

Operating pressure 20kPa - 1200kPa, providing high flow (220 lpm @ 200kPa). The Super-Flo Valve (1" BSPF Inlet) is supplied complete with 300mm Brass Arm, 5½" Blue Ball Float, 600mm Cord and ¾" BSPM & 1" BSPM self-sealing adaptors with O-rings. ½" and 1¼" BSPM adaptors also available as spare parts.

The piston design reduces valve sticking open or closed and the variable open/close action reduces valve "chatter or bounce" and water hammer under high pressures.

CODE	Description
HSFPV2520	Super-Flo Valve c/w 5½" Blue Ball Float
HFLOAT140B	Blue Float Only 5½"
HFLOAT140HI	High Visibility Yellow Float Only 5½"
HSFPISTON	Piston Only c/w O-Ring
HSFORING	O-Ring Only Suit Piston
HSFSEAL	Valve Body Washer Seal Only
HSFARM	Brass Arm Only 300mm Long



### MAX-FLO VALVE – DIAPHRAGM TYPE

Operating pressure 20kPa - 1200kPa, providing high flow (570 lpm @ 200kPa). Valve (1" BSP F Inlet x 1¼" BSP M Outlet – threaded outlet allows for connection to a diffuser tube) supplied complete with Adjustable Extension Arm, 4" Blue Ball Float, 600mm Cord and ¾" BSPM & 1" BSPM self-sealing adaptors with O-rings. ½" and 1¼" BSPM adaptors also available as spare parts.

The Max-Flo Valve has a "SELF CLEANING PILOT" which allows its use in dirty or clean water and the variable open/close action reduces valve "chatter or bounce" and water hammer under high pressures.

CODE	Description
HMFVDV250	Max-Flo Valve as above c/w 4" Blue Ball
HMFVDV325	1" BSP F Inlet c/w 1" Nipple & 1¼"/1" Nipple Adaptor, Arm, Float & String
HFLOAT100B	Blue Float Only 4"
HFLOAT100HI	High Visibility Yellow Float Only 4"
HMFDDIA	Diaphragm with S/Steel Spring
HMFDCAP	Valve Body Cap with Guide Pin



### LEVELLER (2 LEVEL) FLOAT VALVES – DIAPHRAGM TYPE

Leveller 2 Level float valves allow for water level in the tank to drop to a set level before opening until the tank is refilled. Operating pressure 20kPa - 1200kPa, providing high flow (1275 lpm @ 1200kPa). Valve (1" BSPF Inlet x 1¼" BSPM Outlet – threaded outlet allows for connection to a diffuser tube) supplied complete with arm, cord & ball floats. Self-sealing adaptors with O-rings also supplied to adapt inlet to 1¼, 1½" or 2" BSP. The Leveller Valve has a "SELF CLEANING PILOT" which allows its use in dirty or clean water.

CODE	Description
HLFV	"Leveller" 2 Level Tank/Reservoir Valve



### SPARES SUIT SUPER-FLO, MAX-FLO & LEVELLER VALVES:

CODE	Description
HMA15	Male Adaptor with O-ring seal ½" BSPM
HMA20	Male Adaptor with O-ring seal ¾" BSPM
HMA25	Male Adaptor with O-ring seal 1" BSPM
HMA32	Male Adaptor with O-ring seal 1¼" BSPM
HMA15	Long Male Adaptor with O-ring ½" BSPM
HMA20	Long Male Adaptor with O-ring ¾" BSPM
HMA25	Long Male Adaptor with O-ring 1" BSPM
HCORD	650mm Cord & Nut





## • APEX FLOAT VALVE SPARE PARTS

Code	Description
<b>To fit P20- 15, 20 &amp; 25 Valves</b>	
P20- 20/25OR	'O'-ring for sleeve
P20- 20/25PN	cotter pin for lever
P20/25WSH	Sealing washer (inside cap)
P20CAP15/20/25	Outlet Cap & Washer
P20PL20	Sleeve & O-ring
P20ARM2025	Brass Arm (300mm)
P20SHARM20/25	Short Brass Arm (200mm)
<b>To fit both P20- 32,40,50 Valves &amp; P21-32,40,50 Valves</b>	
P20BOLT	S/S Bolt (For fixing Arm to Lever)
P20CAP3250	Threaded exit cap (Outlet cap)
P21OR3250	O-ring (top of sleeve)
P21PIN	Pin, Ring & Tag (For fixing lever to body)
P21SHARM	Short Brass Arm (Male Thread, Serrated Bolt Hole,290mm)
P21WSHR	Sealing washer (inside cap)
<b>To fit P20- 32, 40 &amp; 50 Valves Only</b>	
P20ARM3250	Brass Arm (Male Thread, Serrated Bolt Hole,300mm)
P20LVR3250	Inner Lever (For xing arm to body)
P20SLV3250	White Sleeve plung& O-ring
P20SILENCINGRING	Silencing ring to suit P20 valves
<b>To fit P21- 32, 40 &amp; 50 Valves Only</b>	
P21INARM	Inner Fixed Arm – M x M Threa
P21LVR	Inner Brass Lever (For attaching arms to valve)
P21SLEEVE	Grey Sleeve plunger & O-ring
<b>To fit A20B – 20,25</b>	
A20BARM	Brass Arm (300mm)
A20BCAP	Plastic Dust Cap (Top of valve)
A20BOR	'O'-Ring for sleeve
A20BPIN	Cotter Pin (For attaching arm to valve)
A20BSLV	Sleeve & O-ring
A20BWSHR	Sealing washer (inside cap)
<b>To fit Brass A20 – 20,25</b>	
A20ARM 20/25	Brass Arm & Lever
A2025CAP	Plastic Dust Cap
A20PIN	Cotter Pin
A20PL20/25	Piston Brass
<b>To fit P20E – 15,20 &amp; Space Savers</b>	
P20E15BN	Back nut 15mm
P20E15BW	Back washer 15mm
P20E20BN	Back nut 20mm
P20E20BW	Back washer 20mm
P20EPLSL	Piston with seal
P20ESEAL	Seal



## APEX FLOAT VALVE SPARES CONT'D

Code	Description
<b>To fit XTF 20, 25 &amp; 32</b>	
XTFBODY	Tail end body
XTFCAPASS	Cap assembly c/w lever
XTFBP	Diaphragm backing plate lip seal
XTFDIAF	Apex XTF Valve Dia
XTFRK	Apex Repair Kit Sui
XTFCORD	Nylon Cord 500mm Long (std.)
XTFPIN	Cotter Pin
XTFSPRL	Large S/S spring
XTFFLTR20	Inlet Strainer for ¾" Apex XTF Valve
XTFFLTR25	Inlet Strainer for 1" Apex XTF Valve
XTFFLTR32	Inlet Strainer for 1¼" Apex XTF Valve
<b>To fit A20U 15</b>	
A20UARM	Arm & Lever
<b>Spare Parts to suit TAIWAN BRASS FLOAT VALVES</b>	
FVS31	Brass lever to suit A20-20/25
FVS32A	Brass Piston for A20-20
FVS33A	Brass Piston for A20-25
FVS34	330mm Brass Rod Arm for A20-20/25
<b>Repair Kits</b>	
RKAP	Plastic Full Flow Service Kit Suit P20-15/20/25 Apex Valves
RKRES	Repair Kit Suit Apex P20-32/40/50 Valves Contents: 'O' Ring, Sealing Washer, Cotter Pin, Tag & Bushes
RKRESDL	Repair Kit Suit Apex P21-32/40/50 Dual Level Valves Contents: 'O' Ring, Sealing Washer, Cotter Pin, Tag & Bushes
RKSS	RKSS - Repair Kit Suit Apex High Flow Space Saver Valves P15/20SS
XTFRK	Repair Kit suit Apex XTF20, 25 & 32 Valves Contents: jet assembly,lever,pin, diaphragm & backing plate



## 10. DRINKING BOWLS CAST ALUMINIUM & PLASTIC

<b>RAINDROP CAST ALUMINIUM DRINKING BOWLS (Discount Code: 2.5)</b> Units are rated to 70 Psi & have 1/2" BSP Inlet	
CODE	DESCRIPTION
DB1L	Cast Aluminum Drinking Bowl 3 3/4" Lt. capacity c/w Plug
DB1G	Green Powder Coated Bowl 3 3/4" Lt. capacity c/w Plug
DB2	Trough-A- Matic
DB3	Replacement Float Valve Assembly for DB1L & Db2



DB1L

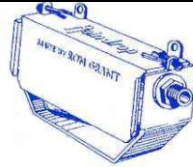

DB2 D



B3

<b>REPLACEMENT PARTS FOR ALUMINIUM DRINKING BOWLS &amp; TROUGH-A-MATICS</b>	
CODE	DESCRIPTION
DBFAC	Float, Arm & Pin
DBBN	1/2" Inlet Body & Nut
DBF	Float c/w Short Stub
DBP	Rubber drain Plug
DBSO	Shut Off rubber
DBPP	Red Plastic Plug
DBL	Lid Plain
DBA	Plastic Arm & Pin
DBPPIN	Plastic Pin

<b>FJORD NYLON DRINKING BOWL with STAINLESS STEEL LID</b>	
CODE	DESCRIPTION
FDB	Nylon Drinking Bowl c/w S/S Lid & Float Valve
FDBSS	S/ Steel Drinking Bowl c/w S/S Lid & Float valve 2.5L
FDRVA	Replacement Float Valve Assembly 1/2" MI BSP

FDBSS



FDB



<b>STOCKBRANDS NYLON DRINKING BOWLS</b>	
CODE	DESCRIPTION
SDB	Nylon Drinking Bowl c/w Float Valve & Float
SDRVA	Replacement Float Valve Assembly 1/2" MI BSP



<b>RELN NYLON AUTOMATIC FLOAT VALVE</b>	
CODE	DESCRIPTION
RELN	3/4" FI BSP Inlet





### 4" SX JR TROUGH PLUG COMPLETE

Consists of Galvanized Steel seat & Plug which has 2 Gal. Steel pressings with a rubber sealing ring between them.

CODE	DESCRIPTION
JRTPC	4" SX Trough Plug – Complete With Rubber & Seat
JRTPB	4" SX Plug Only – No seat, No Rubber
JRTPS	4" SX Trough Seat Only



### NEOPRENE SPONGE TROUGH PLUG RUBBERS

CODE	DESCRIPTION
TPRNEO	To suit 4" JR Southern Cross Trough Plugs

### SQUARE WASH-OUT TROUGH PLUG & RUBBERS

CODE	DESCRIPTION
WOPC6	Trough Plug 316 S/S 6" Square c/w Rubber
WOR6	6" x 6" Rubber Only x 3/4" thk. c/w 1/2" centre hole
WOR12	12" x 6" Rubber Only x 3/4" thk. c/w 2 x 1/2" holes



6" Wash-Out Plug

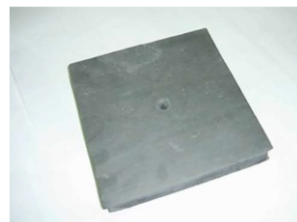

6" Rubber Only



12" Rubber Only

### WASH OUT RUBBER – METRE LENGTH

CODE	DESCRIPTION
WORM	1 Metre Length x 1" Thick x 8" Wide Wash Out Rubber \$/Mtr Length

## • TROUGH RUBBERS & TAPERED SOLID RUBBER TROUGH PLUGS

### BLACK ROUND TAPERED TROUGH PLUG

CODE	DESCRIPTION
TPRT3	3" Dia. Top x 2 3/4" Bottom x 2" High
TPRT4	4 1/2" Dia. Top x 3 3/4" Bottom x 2" High

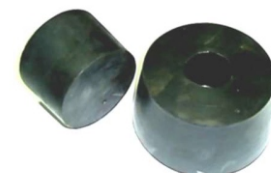





TROUGH RUBBERS	
CODE	DESCRIPTION
TR18	Trough rubber 863mm long to suit 18" Trough
TR21	Trough rubber 965mm long to suit 21" Trough
TR24	Trough rubber 1117.6mm long to suit 24" Trough



TROUGH RUBBER SPONGE STRIP - METRE LENGTH	
CODE	DESCRIPTION
TR6X1M	Trough Rubber Sponge Strip 1 Metre Long x 6" Wide x 3/4" Thick \$/Mtr Length

ROCLA TROUGH RUBBER	
---------------------	--

Standard length pack: 18m

CODE	DESCRIPTION
TRR	11/16"OD x 5/16" ID (price /m)



## • TROUGH BROOMS & HANDLES

STOCK TROUGH BROOMS	
---------------------	--

Made with stiff green bristles & Gal. Steel frame (Prices are without handles)

CODE	DESCRIPTION
TB13	13" Half moon Tr
TB18	18" Half moon Tr
TBR	Rectangular 8 1/2" x 6 1/2" Trough Broom



STOCK TROUGH BROOM HANDLES	
CODE	DESCRIPTION

TBHA4	Aluminum 4' 6" Long x 1" Round
TBHA5	Aluminum 5' Long x 1" Round
TBHA6	Aluminum 6' Long x 1" Round
TBHW5	Wooden 5' Long x 1" Round
TBHW6	Wooden 6' Long x 1" Round





**Irrigation**  
direct.com.au

# ***STOCK TROUGHS, VALVES & FITTINGS***

For Assistance please contact Michael: 0488 917 285 or  
[michael@irrigationdirect.com.au](mailto:michael@irrigationdirect.com.au)

