

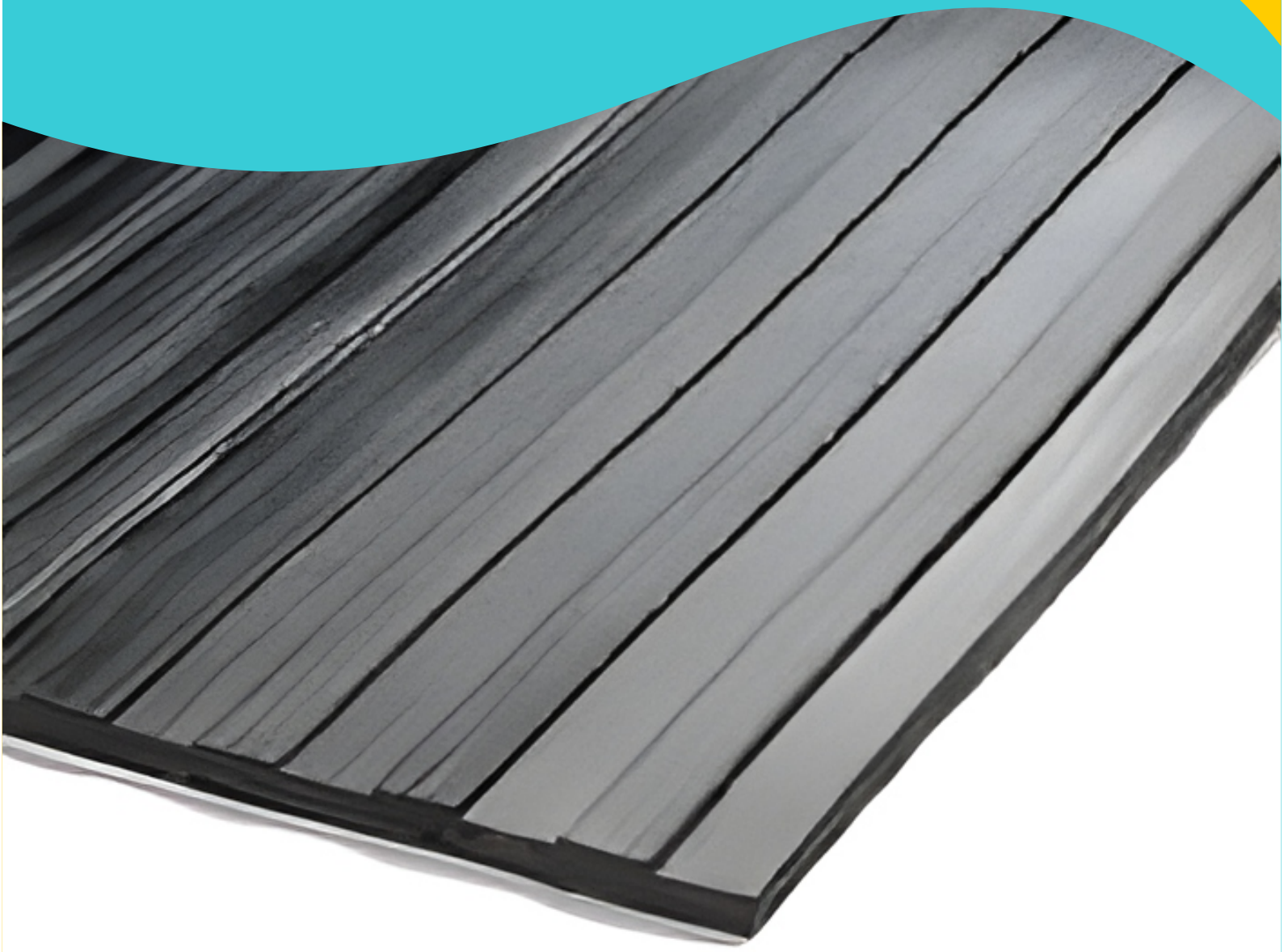

# SPECIALTY RUBBER PRODUCTS





### STUDED MATTING



Snake skin stud matting is a commercial grade, 65 Duro synthetic rubber matting designed for use as a general purpose non slip rubber matting. Matting is supplied with a snake skin studded profile finish, with textured fabric underneath for easy and secure bonding.

P/N	THICKNESS	WIDTH	ROLL
SR-MSF031000	3.0mm	1000mm	10M
SR-MSF031200	3.0mm	1200mm	10M
SR-MSF031500	3.0mm	1500mm	10M
SR-MSF051200	5mm	1200mm	10M
SR-MSF051500	5mm	1500mm	10M



#### TECHNICAL SPECIFICATION

Compound: SBR  
 Colour: Black  
 Specific Gravity: 1.60  
 Elongation: ≥250%  
 Hardness: 80 ±5 shore A  
 Tensile Strength: 5 MPA  
 Temperature: 0°C to +65°C  
 Tear Strength: 15kg/cm

### CHECKERPLATE MATTING



Checker plate matting is a commercial grade, 65 Duro synthetic rubber matting designed for use as a general purpose non slip rubber matting. This design features a checker plate profile, ideal for flooring, tool box treads, tray liners or anywhere needing a non-slip surface.

P/N	THICKNESS	WIDTH	ROLL
SR-MCP31000	3.0mm	1000mm	10M
SR-MCP31200	3.0mm	1200mm	10M
SR-MCP31500	3.0mm	1500mm	10M
SR-MCP51500	5.0mm	1500mm	10M



#### TECHNICAL SPECIFICATION

Compound: SBR  
 Colour: Black  
 Specific Gravity: 1.5  
 Elongation: 200% (min)  
 Tensile Strength: 3.5MPA (min)  
 Hardness: 65 ±5 shore A  
 Temperature: 0°C to +65°C

### EQUINE MATTING



Equine matting is a premium grade, durable and impact resistant 65 Duro synthetic rubber matting designed as a non-slip flooring for horse floats, transport trucks and stables. Insulated and anti-fatigue. Reinforced with heavy nylon fabric for superior tear resistance. Numerous applications in equine and agricultural industries.

P/N	THICKNESS	WIDTH	ROLL
SR-MER081600	8.0mm	1600mm	10M
SR-MER082000	8.0mm	2000mm	10M
SR-COW	17.0mm	1.83mm	10M



#### TECHNICAL SPECIFICATION

Compound: SBR  
 Colour: Black  
 Specific Gravity: 1.5  
 Elongation: 250%  
 Tensile Strength: ≥ 3.5 MPA  
 Hardness: 65 ±5 shore A  
 Temperature: 0°C to +65°C



### WIDE RIB MATTING

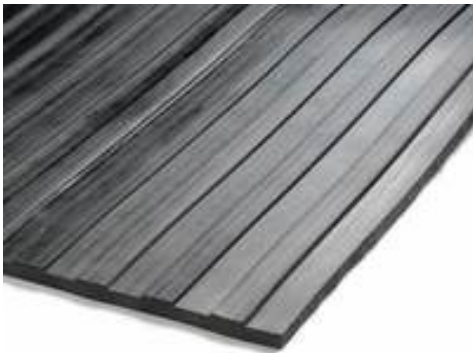

Wide Rib (Big Rib) matting is a commercial grade, 65 Duro synthetic rubber matting designed for use as a general purpose non slip rubber matting. Easy to clean large rib design perfect for any industrial or commercial application

### FINE RIB MATTING



Fine Rib matting is a commercial grade, 65 Duro synthetic rubber matting designed for use as a general purpose non slip rubber matting. Fine rib profile finish on top surface guides liquids away from surface of flooring. Underside has a textured fabric finish to promote secure and easy adhesion. Good resistance to chemicals & oils.

### UTE MAT



UTE matting is a superior grade, 65 Duro synthetic general purpose rubber matting. It has a textured profile finish on the top surface for non-slip assurance. It also contains holes and raised nipples on the underside to allow for water drainage to ensure the matting does not retain moisture.

P/N	THICKNESS	WIDTH	ROLL
SR-MBR031200	3mm	1200mm	10M
SR-MBR031500	3mm	1500mm	10M
SR-MBR031830	3mm	1830mm	10M
SR-MBR032000	3mm	2000mm	10M
SR-MBR051200	5mm	1200mm	10M
SR-MBR051500	5mm	1500mm	10M
SR-MBR051800	5mm	1800mm	10M
SR-MBR052000	5mm	2000mm	10M



#### TECHNICAL SPECIFICATION

Compound: SBR  
 Colour: Black  
 Specific Gravity: 1.50  
 Elongation: ≥250%  
 Hardness: 65 ±5 shore A  
 Tensile Strength: 3.5mpa  
 Temperature: 0°C to +70°C

P/N	THICKNESS	WIDTH	ROLL
SR-MFR031200	3.5mm	1200mm	10M
SR-MFR031500	3.5mm	1500mm	10M
SR-MFR031800	3.5mm	1830mm	10M
SR-MFR032000	3.5mm	2000mm	10M
SR-MFR051500	5mm	1500mm	10M
SR-MFR052000	5mm	2000mm	10M



#### TECHNICAL SPECIFICATION

Compound: SBR  
 Elongation: 280-300%  
 Tensile Strength: ≥ 4-5MPA  
 Hardness: 70 ±5 shore A  
 Density: 1.5g/cm3  
 Temperature: -30°C to +70°C

P/N	THICKNESS	WIDTH	ROLL
SR-UTE	10mm	1830mm	10M



#### TECHNICAL SPECIFICATION

Compound: SBR  
 Elongation: 250%  
 Tensile Strength: ≥ 3.5MPA  
 Hardness: 65 ±5 shore A  
 Density: 1.5g/cm3  
 Temperature: 0°C to +65°C



## WAFFLE PAD (02206)

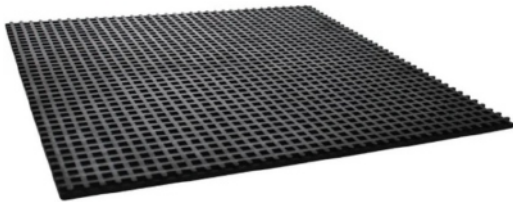

This anti-vibration pad is the simplest and most inexpensive way to isolate vibration, shock, and reduce noise levels of machinery & equipment. Moulded waffle design allows for efficient deflection without loss of stability and it is able to provide maximum resilience and a creep proof grip for the installation of common shop machinery and equipment. UV resistant EPDM rubber 72 Duro hardness with a load rating of 3kg/cm<sup>2</sup>. Waffle pad is easy to install and engineered to be easily trimmed to fit under most equipment. It is suitable for use in machine shops under lathes, milling machines, drill presses, grinders, and metal fabricating equipment. It is also recommended for HVAC, motors, generators, and for utility use as shims and blocks.

P/N	D1	D2	D3	UNIT
MR-WAFFLE	450mm	450mm	8MM	EA

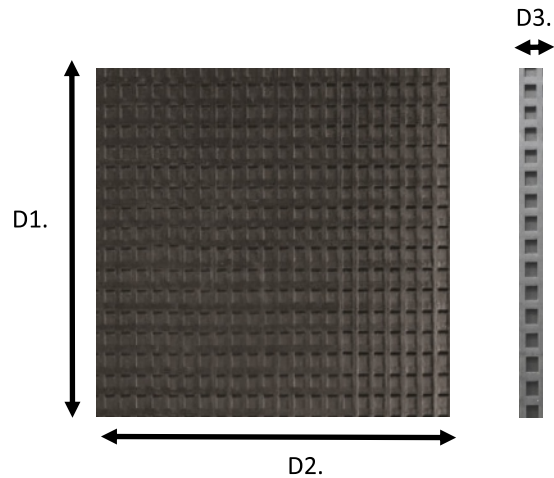

### TECHNICAL SPECIFICATION

Density: 1.62±0.05 g/cm<sup>3</sup>  
 Elongation: ≥240%  
 Tensile Strength: ≥3.2 MPA  
 Hardness: 72±5 shore A  
 Soaking: 48h Weight Change Rate in Soybean Oil at Ambient Temperature ( % ) :≤1.8

## ANTI-FATIGUE MAT



Anti-fatigue matting is a commercial grade, 65 Duro synthetic rubber matting designed for use as a general purpose non slip rubber matting. Finished with a textured profile finish on the top surface for nonslip assurance. It also contains holes and raised nipples on the underside to allow for water drainage and to ensure the matting does not retain moisture. Supplied 915MM X 1525MM with bevelled anti-trip edges is designed primarily for use as an anti-slip and anti-fatigue rubber matting in general purpose industrial applications where staff, in particular, are required to stand for long periods of time.

P/N	D1	D2	D3	UNIT
MR-M02179	915MM	1525MM	10MM	EA

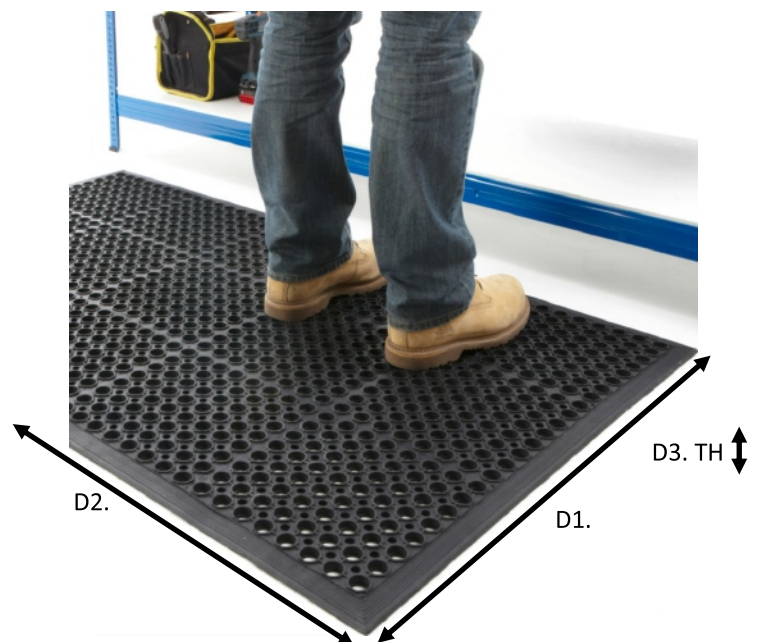

# RUBBER SHEET



## ANTI SLIP LOAD MATTING



Load mat is a black premium grade, durable, solid rubber matting intended for use as an anti slip rubber load restraint device in transport. Designed for bearing higher loads and heavier duty applications, it has an anti-slip finish on both sides, which increases the coefficient of friction between the load carrying surface and the load itself to assist with load securing.

P/N	THICKNESS	WIDTH	ROLL
SR-ASL05	5mm	1200mm	10M
SR-ASL08	8mm	1200mm	10M

### TECHNICAL SPECIFICATION

Compound: NR/SBR  
 Colour: Black  
 Coefficient of Friction (Kinetic): >0.6  
 Specific Gravity: 1.35  
 Elongation: ≥350%  
 Hardness: 65° ±5' shore A  
 Tensile Strength: 7mpa  
 Temperature: -20°C to +70°C



## HORSE FLOAT / EQUINE MAT

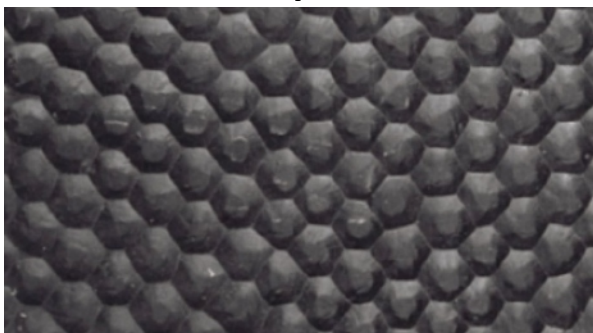

Equine rubber floor matting is a premium grade, durable and impact resistant 65 Duro synthetic rubber designed for use as a non-slip floor matting for horse floats, transport trucks and stables. Equine rubber floor matting is supplied with a turtle-back finish on the top surface for anti-slip assurance even when wet and is reinforced with a heavy nylon fabric to give it superior tear resistance. Equine rubber floor matting is also insulating and anti-fatigue, reducing the need for extra bedding in stalls and will reduce fatigue to horses in areas where they stand for long periods of time. Equine rubber floor matting is supplied with a textured fabric finish on the underside to allow for easy bonding to floors but is also heavy enough to lay flat when simply rolled out into position.

P/N	THICKNESS	WIDTH	ROLL
SR-MER082000	8mm	2000mm	10M
SR-MER102000	10mm	2000mm	10M

### TECHNICAL SPECIFICATION

Compound: SBR  
 Colour: Black  
 Specific Gravity: 1.5  
 Elongation: ≥250%  
 Hardness: 65° ±5' shore A  
 Tensile Strength: 3.5mpa  
 Temperature: -20°C to +70°C



# RUBBER SHEET



## GYM MAT



Gym matting providing comfort & cushioning for all kinds of personal & commercial applications.

P/N	THICKNESS	WIDTH	ROLL
SR-GYMB08	8mm	1250mm	10M
SR-MGYM	9mm	1200mm	10M



## MARBLE RUBBER

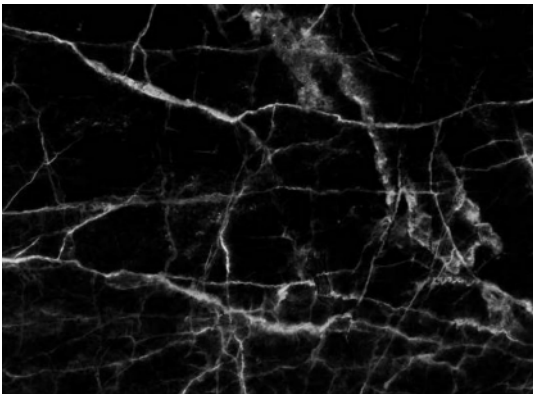

Marble rubber used as a cost effective decorative flooring, easy to install & keep clean. Also used for flooring on buses, taxis & various commercial vehicles.

P/N	THICKNESS	WIDTH	ROLL
SR-M3MM2000	3.0mm	2000mm	10M



## ELECTRICAL SWITCHBOARD MAT

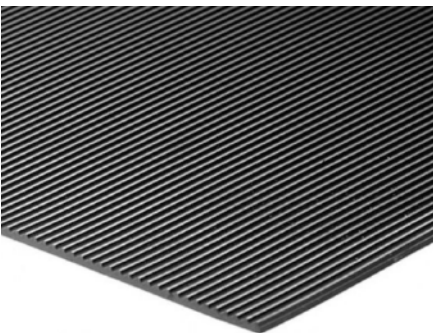

P/N	THICKNESS	WIDTH	ROLL
SR-ESM06	6.3mm	1000mm	10M

*\* Branded to AS/NZS 2978:1995 for easy identification*

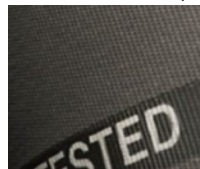

Switchboard matting is designed for use as an electrical insulating safety device. Tested & certified to **AS/NZS 2978-1995: INSULATING MATS FOR ELECTRICAL PURPOSES**. For use as an isolating safety matting where voltages do not exceed 650V DC or 650V AC RMS.

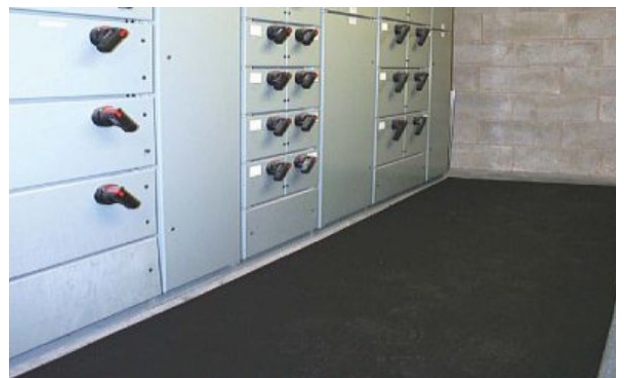

# RUBBER

## DOCKING RUBBER



### DOCKING RUBBER



Protect property & vehicles from damage by using these heavy duty moulded docking rubbers. Suitable for loading bays, docks, jetties, transport yards, depots, trucks, trailers, wharves etc. Manufactured from extremely durable & hard-wearing EPDM blended rubber compound. Easily drilled for mounting & can be fixed directly to the bumpers of vehicles.

\* Items with MOQ (Min Order Qty may apply)

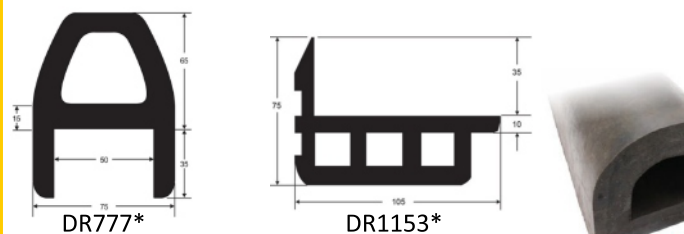
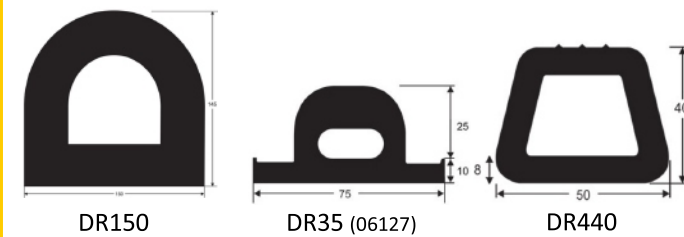
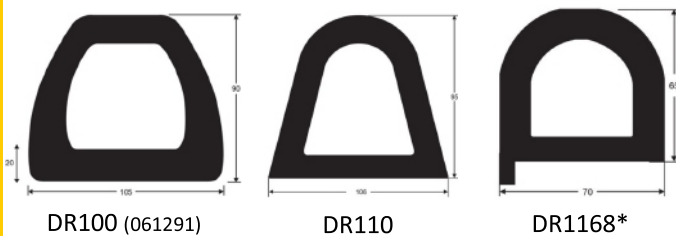

P/N	HEIGHT	WIDTH	THICK-NESS	LENGTH
MR-DR300	110mm	90mm	20mm	300mm
MR-DR1000	110mm	90mm	20mm	1000mm
MR-DR1200	94mm	104mm	20mm	1200mm
ER-DR100	90mm	105mm	20mm	5000mm
ER-DRW100 WHITE	90mm	105mm	20mm	5000mm
ER-DR110	95mm	106mm	20mm	4000mm
ER-DR1125/1	16mm	25mm		
ER-DR1126/1	22mm	32mm		
ER-DR1127/1	32mm	42mm		
ER-DR1153*	75mm	105mm	10mm	MTO
ER-DR1168*	65mm	70mm		4000mm
ER-DR150	145mm	150mm		4000mm
ER-DR440	40mm	50mm	8mm	3000mm
ER-DR441	65mm	75mm	10mm	3000mm
ER-DR442	80mm	100mm	12mm	3000mm
ER-DR50	40mm	50mm	8mm	4000mm
ER-DRW50 WHITE	40mm	50mm	8mm	5000mm
ER-DR554	92mm	103.6mm	19.5mm	3000mm
ER-DR60	60mm	60mm		4000mm
ER-DR75	65mm	75mm	15mm	4000mm
ER-DRW75 WHITE	65mm	75mm	15mm	5000mm
ER-DR777*	100mm	75mm	15mm	3000mm
ER-DR35	25mm	75mm	10mm	30m/4m

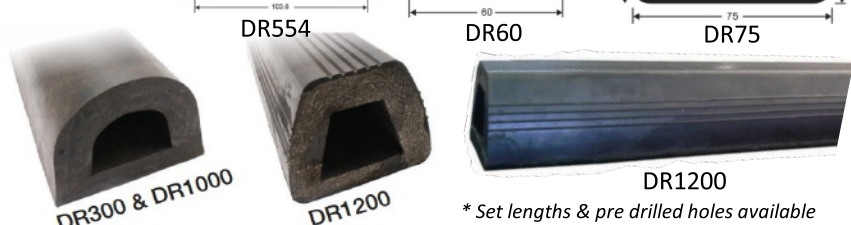
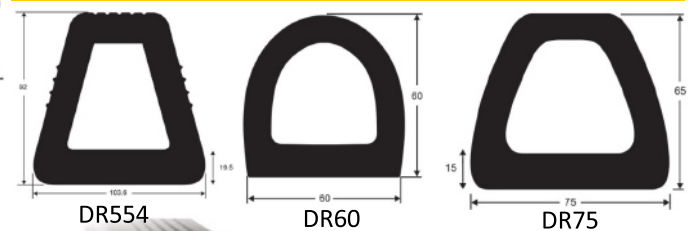

\* Set lengths & pre drilled holes available



# RUBBER

## HOIST / CRANE PADS



### HOIST PAD

Vehicle hoist pads manufactured from extremely durable high grade rubber compound, to suit:

- MONAR
- TECALEMIT
- BISHAMON
- POWERREX



MR-RHPB001



RUBBER HOIST PAD TO SUIT BISHAMON RKN40NW, NSA30, NSP30 HOISTS WITH METAL REINFORCED MOUNTING PLATE NO SCREWS INCLUDED

MR-RHPB004



RUBBER HOIST PAD TO SUIT BISHAMON SPW3000, SPW2500 HOISTS WITH METAL REINFORCED MOUNTING PLATE NO SCREWS INCLUDED

MR-RHPM005



RUBBER HOIST PAD TO SUIT MOLNAR MF17505-85A-3T, 95A-3T & 4T HOISTS

MR-RHPP003



RUBBER HOIST PAD TO SUIT 2 & 3 HOLE POWERREX 2900F 2900FR HOISTS SCREWS NOT INCLUDED

MR-RHPT002



RUBBER HOIST PAD TO SUIT TECALEMIT V15100 & 3000 SERIES HOISTS



### CRANE PAD

Excellent support for crane and excavator feet, stabilizer / outrigger cylinder supports or other equipment. Made from superior rubber compound, the rubber crane pad leaves no mark on surfaces and landscape damage is reduced. Provides a safer and stable footing especially in wet ground conditions. Heavy-duty, weather resistant anti-slip surface design to enhance safety grip. Easy grab handle positioning storing.

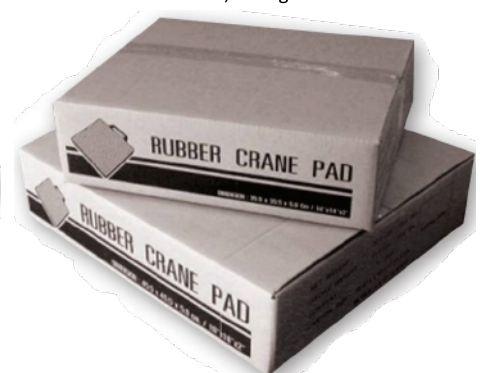

P/N	HEIGHT	WIDTH	THICKNESS
MR-92139	355mm	355mm	50mm
MR-92140	460mm	460mm	50mm

#### TECHNICAL SPECIFICATION

Compressed Distance	Compressive Load
5mm	22,920 Kgf
10mm	74,392 Kgf
15mm	127,842 Kgf
20mm	182,225 Kgf
21.5mm	217,522 Kgf



# RUBBER

## WHEEL CHOCKS



MR-WC1467A		MR-WC1468A		MR-WC1468AK (2 pack)	
<b>Length</b>	205mm	<b>Length</b>	205mm	<b>Length</b>	205mm
<b>Width</b>	130mm	<b>Width</b>	205mm	<b>Width</b>	205mm
<b>Height</b>	100mm	<b>Height</b>	105mm	<b>Height</b>	105mm
<b>Weight</b>	1kg	<b>Weight</b>	2kg	<b>Weight</b>	2kg
	<b>Small</b>		<b>Medium</b>		<b>Medium</b>

MR-WC2556A		MR-WC2556AY		MR-WC3783	
<b>Length</b>	260mm	<b>Length</b>	260mm	<b>Length</b>	300mm
<b>Width</b>	180mm	<b>Width</b>	180mm	<b>Width</b>	300mm
<b>Height</b>	210mm	<b>Height</b>	210mm	<b>Height</b>	260mm
<b>Weight</b>	4.5kg	<b>Weight</b>	4.5kg	<b>Weight</b>	12kg
	<b>Large Half Moon</b>		<b>Large Half Moon</b>		<b>Jumbo Half Moon</b>

MR-WC1086		MR-WC1087		MR-WC1088		MR-WC1089	
<b>Length</b>	250mm	<b>Length</b>	250mm	<b>Length</b>	255mm	<b>Length</b>	250mm
<b>Width</b>	200mm	<b>Width</b>	215mm	<b>Width</b>	125mm	<b>Width</b>	90mm
<b>Height</b>	160mm	<b>Height</b>	155mm	<b>Height</b>	150mm	<b>Height</b>	150mm
<b>Weight</b>	4kg	<b>Weight</b>	9.5kg	<b>Weight</b>	2.5kg	<b>Weight</b>	2.5kg
	<b>Pyramid</b>		<b>Pyramid</b>		<b>Pyramid</b>		<b>Pyramid</b>

MR-WC24483		MR-WC1155		MR-WC1275	
<b>Length</b>	205mm	<b>Length</b>	155mm	<b>Length</b>	275mm
<b>Width</b>	105mm	<b>Width</b>	100mm	<b>Width</b>	160mm
<b>Height</b>	90mm	<b>Height</b>	75mm	<b>Height</b>	150mm
<b>Weight</b>	3kg	<b>Weight</b>	1kg	<b>Weight</b>	4kg
	<b>Small</b>		<b>Small</b>		<b>Medium</b>

Rope length 900mm

Manufactured from an extremely durable and hardwearing EPDM blended rubber compound, our range of wheel chock products shown in this catalogue have been independently tested to the load factors shown in the SAE J348 (Society Of Automotive Engineers) standard. All wheel chocks were found to meet and in some cases exceeded the required load ratings in the Standard.



## BRACKET STRAP

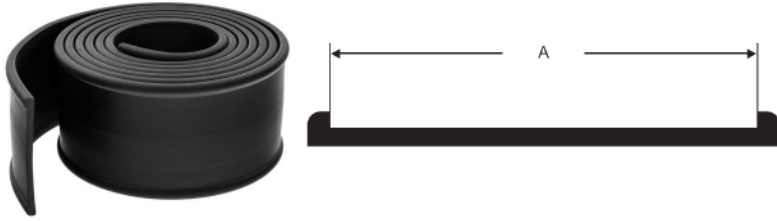

Manufactured from extremely durable & hardwearing rubber in either EPDM & NBR compounds. Side envelope to ensure strap is confined to the rubber. Use NBR for oil & fuel resistance.



P/N	A	MATERIAL
ER-BS25EPDM*	25mm	EPDM
ER-BS50EPDM*	50mm	EPDM
ER-BS75EPDM*	75mm	EPDM
ER-BS25NBR*	25mm	NBR
ER-BS50NBR	50mm	NBR
ER-BS52NBR*	52mm	NBR
ER-BS54NBR	54mm	NBR
ER-BS75NBR	75mm	NBR
ER-BS78NBR*	78mm	NBR

\* Items with MOQ (Min Order Qty may apply)

## TANK STRAP



Manufactured from extremely durable & hardwearing rubber in either EPDM & NBR compounds. Side envelope to ensure strap is confined to the rubber. Use NBR for oil & fuel resistance.

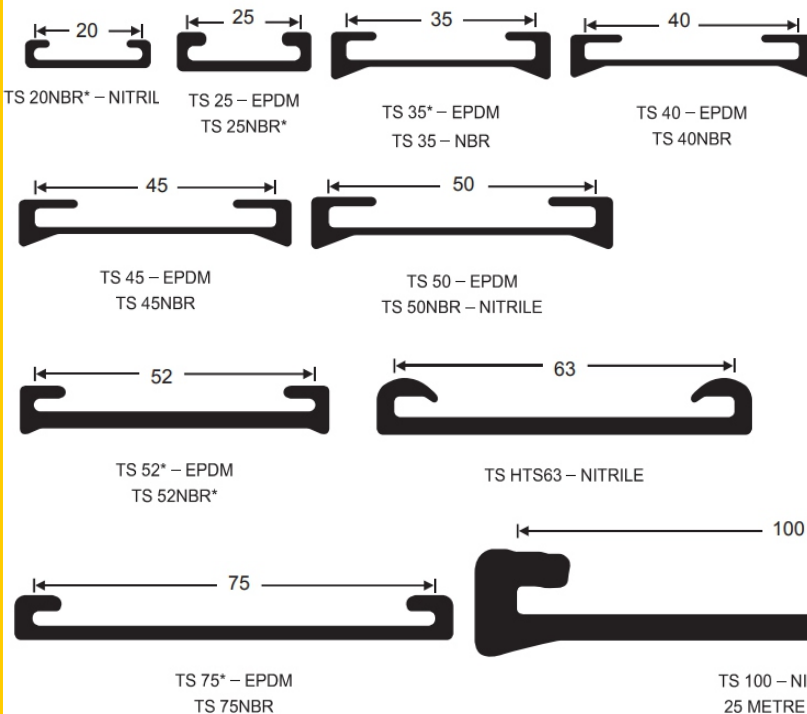

P/N	A	MATERIAL
ER-TS25EPDM	25mm	EPDM
ER-TS35EPDM*	35mm	EPDM
ER-TS40EPDM	40mm	EPDM
ER-TS45EPDM	45mm	EPDM
ER-TS50EPDM	50mm	EPDM
ER-TS52EPDM*	52mm	EPDM
ER-TS75EPDM*	75mm	EPDM
ER-TS20NBR	20mm	NBR
ER-TS25NBR*	25mm	NBR
ER-TS35NBR	35mm	NBR
ER-TS40NBR	40mm	NBR
ER-TS45NBR	45mm	NBR
ER-TS50NBR	50mm	NBR
ER-TS52NBR*	52mm	NBR
ER-TSHTS63NBR	63mm	NBR
ER-TS75NBR	75mm	NBR
ER-TS100NBR	100mm	NBR

\* Items with MOQ (Min Order Qty may apply)

# RUBBER

## BUFFERS, MOUNTS & GUARDS



### HD BUFFERS



Heavy duty buffers with moulded mounting holes for easy fixing & manufactured from extremely durable & hardwearing 75 Duro hardness EPDM blended rubber compound. Ideal for medium weight truck bumpers, steel fire doors, or any industrial application where non cyclic buffing is experienced

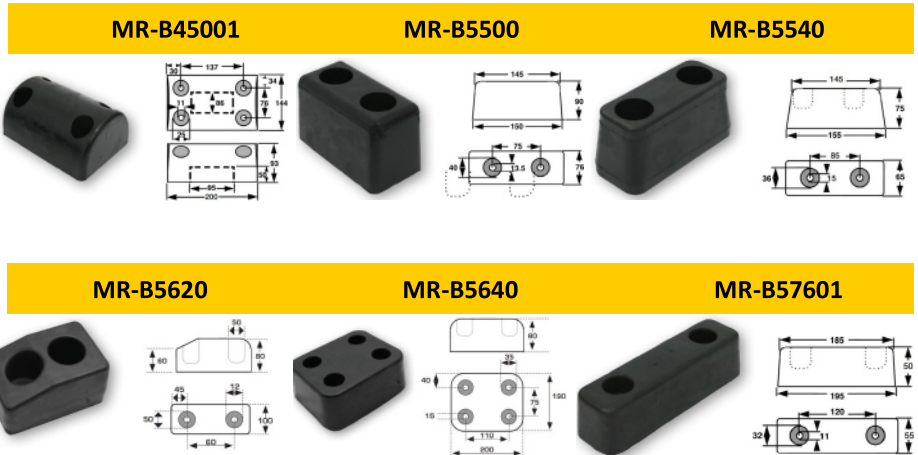

### BUMPER MOUNTING



Solid durable hard wearing EPDM moulded rubber reduces vibration & noise. Ideal for machine mounts, legs stands, protecting doors, pillars, walls, truck bumpers & various industrial applications.

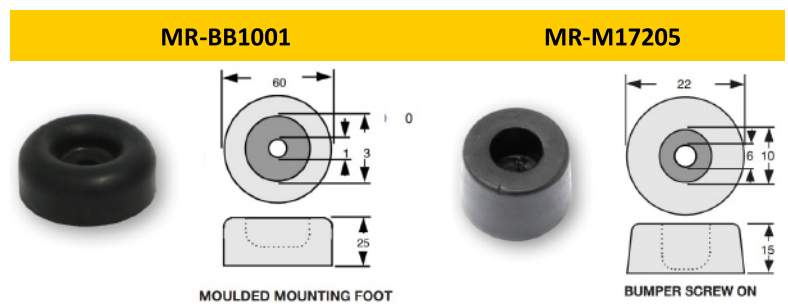

### PILLAR GUARD

These high quality, natural rubber corner guards are ideal for use in all manner of car parks, hospitals, schools, shopping centres and factory complexes. They are suitable for various high use areas. Ideal for providing protection from damage to buildings and vehicles in car parks, loading bays, and storage areas.

P/N	LENGTH	WIDTH	MATERIAL	COLOUR
MR-92141	165mm	80x80mm	NR	BLACK
MR-92142	165mm	80x80mm	NR	YELLOW
MR-92206	1000mm	80x80mm	NR	YELLOW
MR-92207	1000mm	80x80mm	NR	BLACK

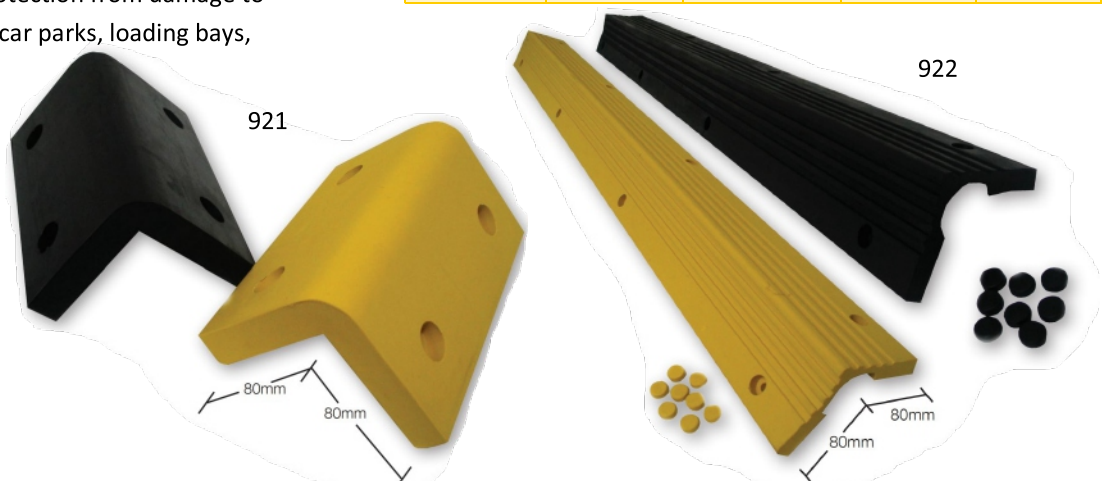



## CABLE PROTECTORS



Manufactured from extremely durable & hardwearing material, cable protectors as the name suggests protects cables, wiring, leads, pipes & hoses where there is thoroughfare & or trip hazards.

P/N	WIDTH	HEIGHT
ER-CP7016	70mm	16mm
ER-CP9020	90mm	19.87mm
ER-CP12028	120mm	26.5mm
ER-CPD2520	120mm	26.5mm
ER-CP13020	130mm	20mm
ER-CP15030	150mm	30mm
ER-CP15048	150mm	48mm

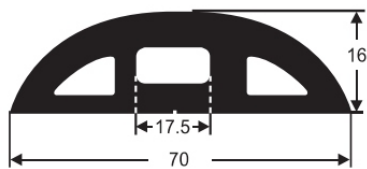
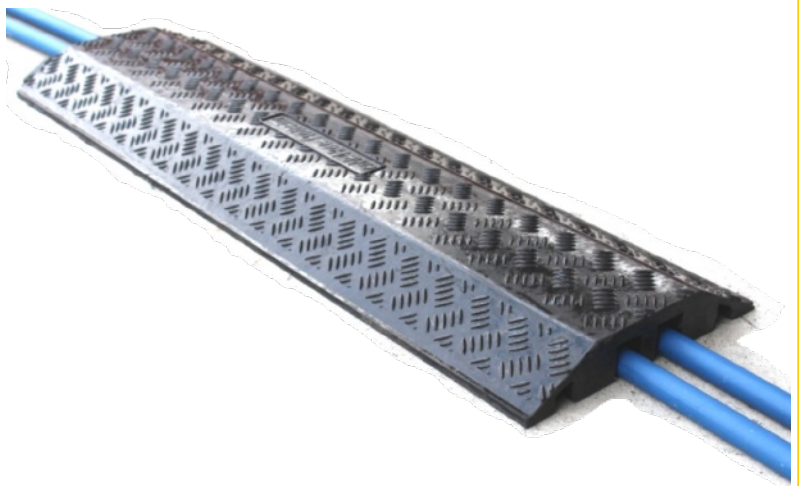

CP 7016 – 30 METRE COIL

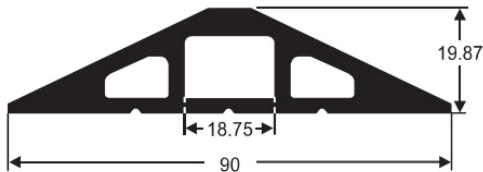

CP 9020 – 30 METRE COIL

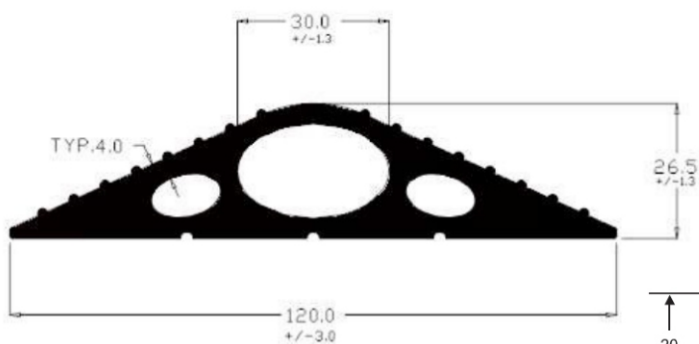

PLA CPD2520

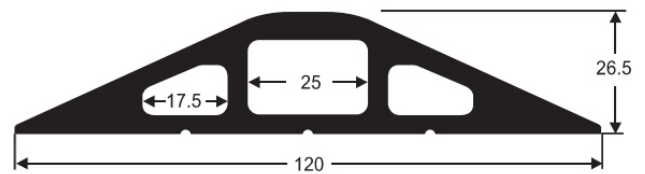

CP 12028 – 30 METRE COIL

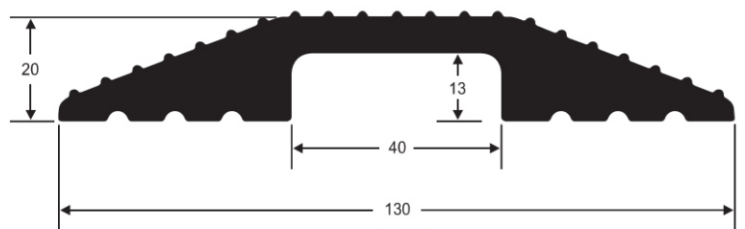

CP 13020

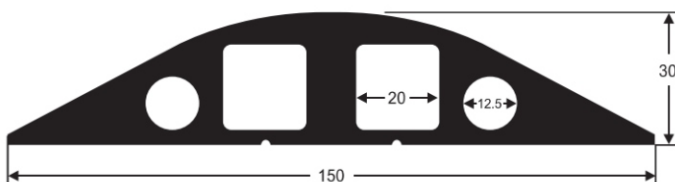

CP 15030 – 20 METRE COIL

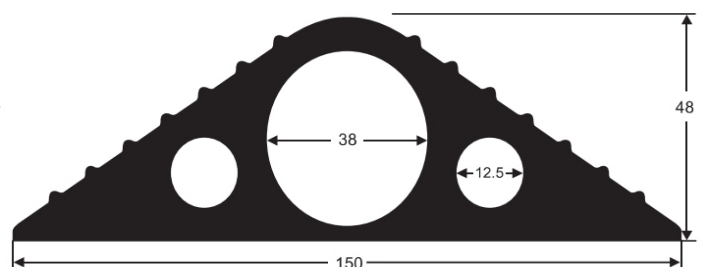

CP 15048 – 20 METRE COIL

# RUBBER

## TIE DOWN / DOOR SEAL



### TIE DOWNS



Heavy duty tie downs made from natural rubber with quick grip hooks each end. NB: *Not UV Stabilised.*

Wall mounted tie down merchandiser saves space, easy to re-stock & is great for "Point Of Sale" in your workshop or counter area.

Merchandiser is 380mm x 120mm

**MR-74-003** 20 of each of the 4 sizes

**MR-74-004** 30 of each of the 4 sizes

**WARNING:** Do not extend rubber tie down strips beyond their recommended maximum stretch limits

P/N	LENGTH	REC STRETCH	PACK QTY
MR-74-010-10	254mm	330mm	10
MR-74-0150-10	381mm	481mm	10
MR-74-021-10	533mm	750mm	10
MR-74-031-10	787mm	1000mm	10



### TARP TIE DOWNS



Heavy duty tarpaulin (dog-bone) tie downs made from natural rubber allow quick & easy fixing.

P/N	LENGTH	WIDTH	PACK QTY
MR-DOG	315mm	60mm	10

### MCDONALDS DOOR SEAL



Durable hard wearing moulded rubber door seal specifically engineered to meet McDonalds standards. 44mm x 1000mm length.

#### MR-01625

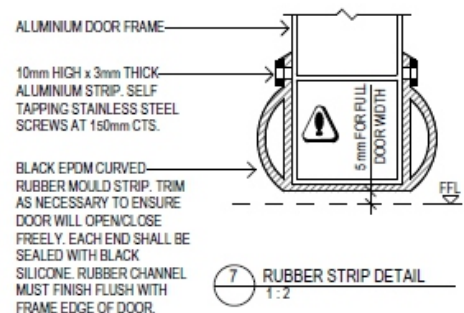



### GUNWALE

MR-GW30(B/W)



MR-GW35(B/W)



MR-GW40(B/W)

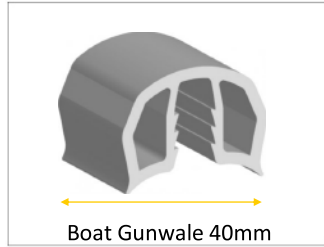

MR-GW50(B/W)

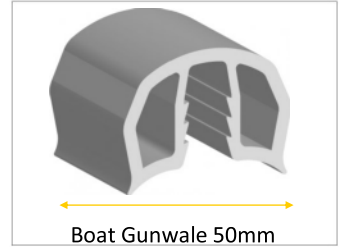

\* Available in Black (B) or White (W)

MR-GW55(B/W)



MR-GWD50(B/W)

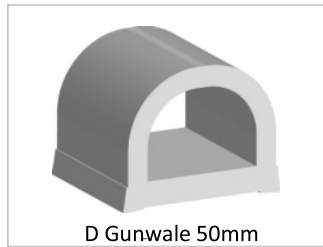

MR-GWD65(B/W)

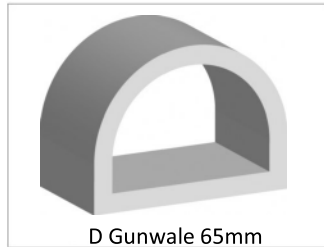

MR-GWD80(B/W)

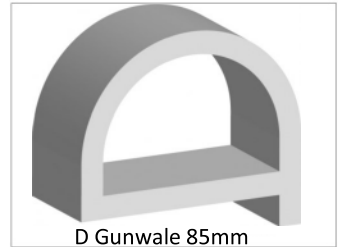

\* Available in Black (B) or White (W)

MR-GWC(B/W)



MR-GWEC(B/W)



MR-GWI(B/W)

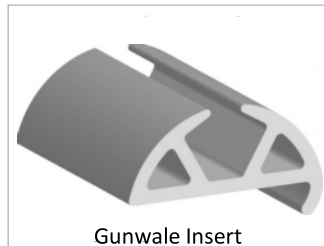

MR-GWIS(B/W)



\* Available in Black (B) or White (W)

MR-ET(B/W)



MR-DET(B/W)



MR-PFW

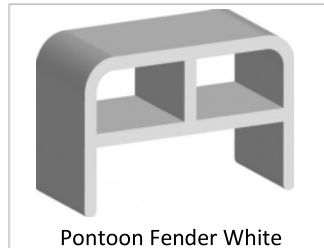

MR-PBW

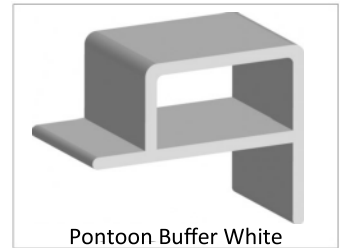

MR-VBW

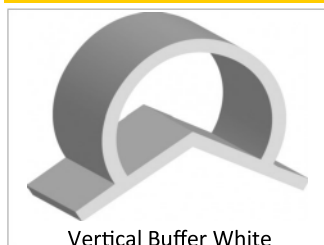

MR-GWB(B/W)



MR-GWCE(BLACK)



MR-GWCE(BLUE)



Please contact us for other variations, sizes & colour options, Some items made to order & MOQ may apply.



### POLYETHYLENE FOAM TAPE

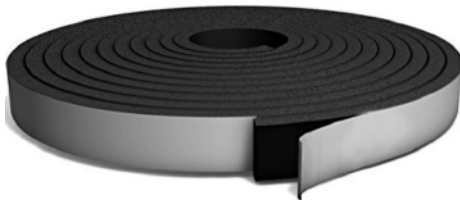

Polyethylene closed cell foam tape 9100 series with aggressive solvent acrylic adhesive. Medium to soft density offering exceptional sealing properties. 6mm & greater size is flame resistant as per FMVSS 302 & If burnt smoke is non-toxic. Excellent resistance to ageing, weathering, sound transmission, water absorption, ozone, UV & resistant to most chemicals. ROHS compliant to directive 2002/95/EC. -15°C to +80°C.

*\*Also available in white POA.*



#### TECHNICAL SPECIFICATION

Backing: Expanded cross linked polyethylene  
 Colour: Charcoal Grey  
 Adhesive: Synthetic rubber  
 Nom. Density: 33 Kg/m<sup>3</sup> (DIN 53420)  
 Elongation: 145%  
 Temp: -15°C to +80°C  
 Thermal Conductivity: 0.036 W/mk (DIN 56212)  
 Water Tightness: 100% @ 10% compression  
 Water Absorption: ≤ 1%

P/N	THICKNESS	WIDTH	ROLL MT
TP-PE910306	3mm	6mm	25
TP-PE910309	3mm	9mm	25
TP-PE910312	3mm	12mm	25
TP-PE910318	3mm	18mm	25
TP-PE910324	3mm	24mm	25
TP-PE910336	3mm	36mm	25
TP-PE910348	3mm	48mm	25
TP-PE910606	6mm	6mm	15
TP-PE910609	6mm	9mm	15
TP-PE910612	6mm	12mm	15
TP-PE910618	6mm	18mm	15
TP-PE910624	6mm	24mm	15
TP-PE910630	6mm	30mm	15
TP-PE910636	6mm	36mm	15
TP-PE910648	6mm	48mm	15
TP-PE910909	9mm	9mm	10
TP-PE910912	9mm	12mm	10
TP-PE910918	9mm	18mm	10
TP-PE910924	9mm	24mm	10
TP-PE910936	9mm	36mm	10
TP-PE910948	9mm	48mm	10
TP-PE911212	12mm	12mm	7
TP-PE911218	12mm	18mm	7
TP-PE911224	12mm	24mm	7
TP-PE911236	12mm	36mm	7
TP-PE911248	12mm	48mm	7

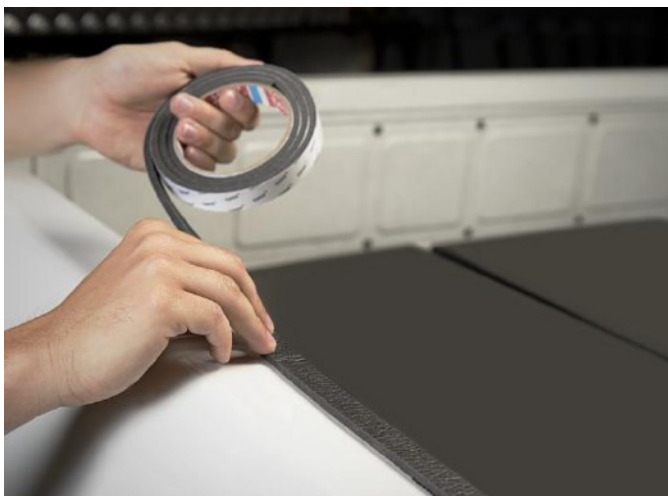



### EPDM RUBBER FOAM TAPE

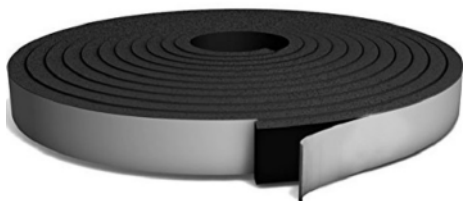

Expanded EPDM closed cell rubber foam tape 6200 series with aggressive solvent acrylic adhesive. Medium density offering quick recovery from compression exceptional sealing properties. Flame resistant as per FMVSS 302 & free from CFC & HCFC. Excellent resistance to oils, ageing, weathering, sound transmission, water absorption, ozone, & UV. ROHS compliant to directive 2002/95/EC.

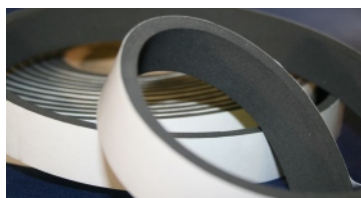

#### TECHNICAL SPECIFICATION

Adhesive power: 980gm/cm  
 Nom. Density: 125-165 Kg/m<sup>3</sup> (D3575)  
 Tensile Strength: 60 N/cm<sup>2</sup> (ASTM D412)  
 Elongation: 180-220% (ASTM D412)  
 Compression Set: 4% (ASTM D1056)  
 Hardness: 40-50 Shore Hardness  
 Colour: Black  
 Adhesive: Solvent Acrylic  
 Temp: -30°C to +130°C

P/N	THICKNESS	WIDTH	ROLL MT
TP-NS620206	1.6mm	6mm	25
TP-NS620209	1.6mm	9mm	25
TP-NS620212	1.6mm	12mm	25
TP-NS620218	1.6mm	18mm	25
TP-NS620224	1.6mm	24mm	25
TP-NS620306	3.2mm	6mm	25
TP-NS620309	3.2mm	9mm	25
TP-NS620310	3.2mm	10mm	25
TP-NS620312	3.2mm	12mm	25
TP-NS620318	3.2mm	18mm	25

P/N	THICKNESS	WIDTH	ROLL MT
TP-NS620324	3.2mm	24mm	25
TP-NS620336	3.2mm	36mm	25
TP-NS620348	3.2mm	48mm	25
TP-NS620360	3.2mm	60mm	25
TP-NS620506	4.8mm	6mm	15
TP-NS620512	4.8mm	12mm	15
TP-NS620518	4.8mm	18mm	15
TP-NS620524	4.8mm	24mm	15
TP-NS620536	4.8mm	36mm	15
TP-NS620548	4.8mm	48mm	15
TP-NS620606	6.4mm	6mm	15
TP-NS620609	6.4mm	9mm	15
TP-NS620612	6.4mm	12mm	15
TP-NS620615	6.4mm	15mm	15
TP-NS620618	6.4mm	18mm	15
TP-NS620624	6.4mm	24mm	15
TP-NS620636	6.4mm	36mm	15
TP-NS620648	6.4mm	48mm	15
TP-NS620909	9.5mm	9mm	10
TP-NS620912	9.5mm	12mm	10
TP-NS620918	9.5mm	18mm	10
TP-NS620924	9.5mm	24mm	10
TP-NS620936	9.5mm	36mm	10
TP-NS621209	12.7mm	9mm	7
TP-NS621210	12.7mm	10mm	7
TP-NS621212	12.7mm	12mm	7
TP-NS621218	12.7mm	18mm	7
TP-NS621224	12.7mm	24mm	7
TP-NS621236	12.7mm	36mm	7
TP-NS621248	12.7mm	48mm	7





### NEOPRENE RUBBER FOAM TAPE

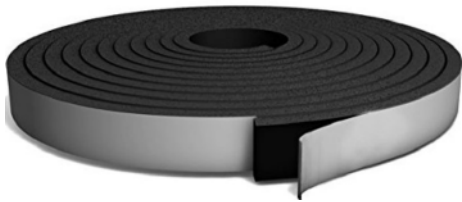

Expanded Neoprene closed cell rubber foam tape 6100 series with aggressive solvent acrylic adhesive. Medium density offering quick recovery from compression exceptional sealing properties. Flame resistant as per FMVSS 302 & free from CFC & HCFC. Excellent resistance to oils, ageing, weathering, sound transmission, water absorption, ozone, & UV. ROHS compliant to directive 2002/95/EC.

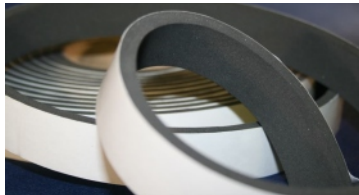

#### TECHNICAL SPECIFICATION

Adhesive power: 980gm/cm  
 Nom. Density: 140-190 Kg/m<sup>3</sup> (DIN 53420)  
 Tensile Strength: 56 N/cm<sup>2</sup> (ASTM D412)  
 Elongation: ≥ 180-220%  
 Compression Set: 4% (ASTM D1056)  
 Hardness: 40-50 Shore Hardness  
 Colour: Black  
 Adhesive: Solvent Acrylic  
 Temp: -30°C to +130°C

P/N	THICKNESS	WIDTH	ROLL MT
TP-NS610206	1.6mm	6mm	25
TP-NS610209	1.6mm	9mm	25
TP-NS610212	1.6mm	12mm	25
TP-NS610218	1.6mm	18mm	25
TP-NS610224	1.6mm	24mm	25
TP-NS610306	3.2mm	6mm	25
TP-NS610309	3.2mm	9mm	25
TP-NS610310	3.2mm	10mm	25
TP-NS610312	3.2mm	12mm	25
TP-NS610318	3.2mm	18mm	25

P/N	THICKNESS	WIDTH	ROLL MT
TP-NS610324	3.2mm	24mm	25
TP-NS610336	3.2mm	36mm	25
TP-NS610348	3.2mm	48mm	25
TP-NS610360	3.2mm	60mm	25
TP-NS610506	4.8mm	6mm	15
TP-NS610512	4.8mm	12mm	15
TP-NS610518	4.8mm	18mm	15
TP-NS610524	4.8mm	24mm	15
TP-NS610536	4.8mm	36mm	15
TP-NS610548	4.8mm	48mm	15
TP-NS610606	6.4mm	6mm	15
TP-NS610609	6.4mm	9mm	15
TP-NS610612	6.4mm	12mm	15
TP-NS610615	6.4mm	15mm	15
TP-NS610618	6.4mm	18mm	15
TP-NS610624	6.4mm	24mm	15
TP-NS610636	6.4mm	36mm	15
TP-NS610648	6.4mm	48mm	15
TP-NS610909	9.5mm	9mm	10
TP-NS610912	9.5mm	12mm	10
TP-NS610918	9.5mm	18mm	10
TP-NS610924	9.5mm	24mm	10
TP-NS610936	9.5mm	36mm	10
TP-NS611209	12.7mm	9mm	7
TP-NS611210	12.7mm	10mm	7
TP-NS611212	12.7mm	12mm	7
TP-NS611218	12.7mm	18mm	7
TP-NS611224	12.7mm	24mm	7
TP-NS611236	12.7mm	36mm	7
TP-NS611248	12.7mm	48mm	7
TP-NS611918	19mm	18mm	5
TP-NS611924	19mm	24mm	5

# PINCHWELD

PVC/EPDM SPONGE



**MR-398844B**

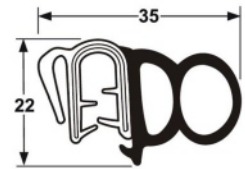

Grip Range: 1.0 - 3.0 mm

**MR-60054 BLACK**

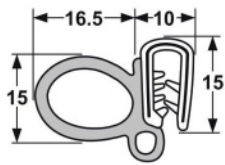

Grip Range: 1.0 - 3.0 mm

**MR-60055N BLACK**



Grip Range: 1.0 - 2.5 mm

**MR-60056B BLACK**

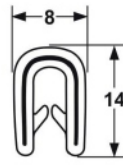

Grip Range: 1.0 - 2.5 mm

**MR-60058 BLACK**

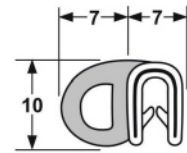

Grip Range: 1.0 - 2.0 mm

**MR-60059 BLACK**

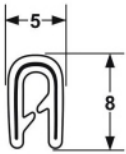

Grip Range: 1.0 - 2.0 mm

**MR-60063 BLACK**

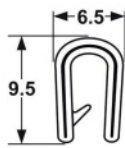

Grip Range: 1.0 - 2.5 mm

**MR-60801 CHARCOAL**

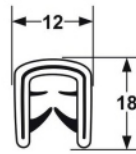

Grip Range: 2.0 - 5.0 mm

**MR-60802 BLUE/GREY**

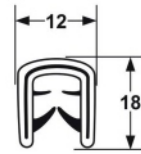

Grip Range: 2.0 - 5.0 mm

**MR-66035**

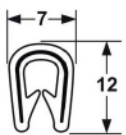

Grip Range: 1.0 - 2.5 mm

**MR-66037**

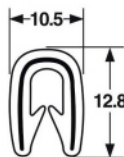

Grip Range: 1.0 - 3.0 mm

**MR-66083 BLACK**

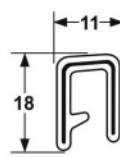

Grip Range: 4.0 - 6.0 mm

**MR-66084 BLACK**

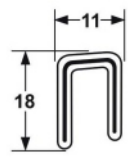

Grip Range: 6.0 - 8.0 mm

**MR-66173 BLACK**

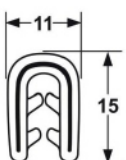

Grip Range: 1.0 - 3.0 mm

**MR-66176 GREY**

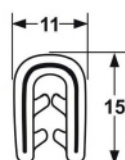

Grip Range: 1.0 - 3.0 mm

**MR-668295 BLACK**

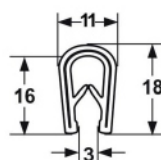

Grip Range: 2.0 - 5.0 mm

**MR-668296 WHITE**

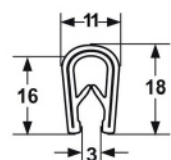

Grip Range: 2.0 - 5.0 mm

Please note that the materials have been tested to comply with the requirements of FMVSS302 (Federal Motor Vehicle Safety Standard). Submitted samples shall not burn, nor transmit a flame front across its surface at a rate of more than 102mm per minute.

# PINCHWELD

## EPDM RUBBER & SPONGE



MR-66002

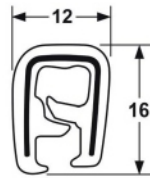

Grip Range: 1.0 - 4.0 mm

MR-66003

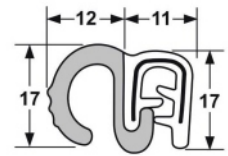

Grip Range: 1.0 - 4.0 mm

MR-66004

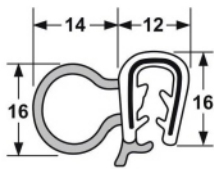

Grip Range: 1.0 - 4.0 mm

MR-66005

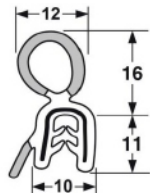

Grip Range: 1.0 - 2.5 mm

MR-66006

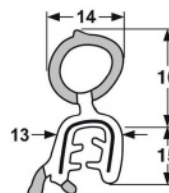

Grip Range: 1.0 - 3.0 mm

MR-66007

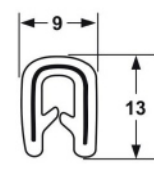

Grip Range: 1.0 - 3.0 mm

MR-66008

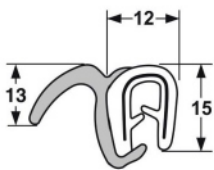

Grip Range: 1.0 - 3.0 mm

MR-66009

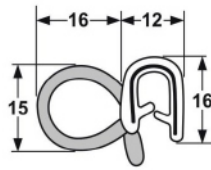

Grip Range: 1.0 - 3.0 mm

MR-66010

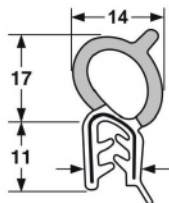

Grip Range: 1.0 - 3.0 mm

MR-66011

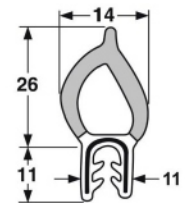

Grip Range: 1.0 - 2.5 mm

MR-66012

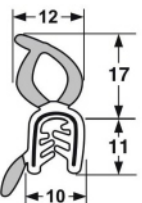

Grip Range: 1.0 - 2.5 mm

MR-66013

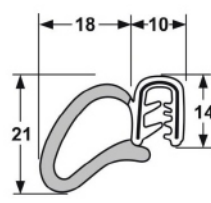

Grip Range: 1.0 - 3.0 mm

MR-66014

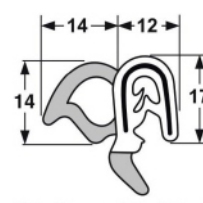

Grip Range: 1.0 - 3.0 mm

MR-66015

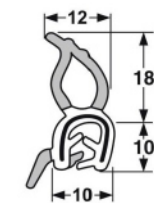

Grip Range: 1.0 - 3.0 mm

MR-66016

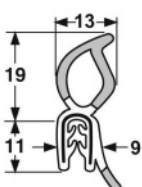

Grip Range: 1.0 - 2.0 mm

MR-66017

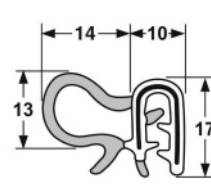

Grip Range: 1.0 - 4.0 mm

MR-66018

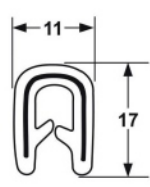

Grip Range: 1.0 - 4.0 mm

MR-66020

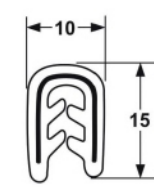

Grip Range: 1.0 - 4.0 mm

Please note that the materials have been tested to comply with the requirements of FMVSS302 (Federal Motor Vehicle Safety Standard). Submitted samples shall not burn, nor transmit a flame front across its surface at a rate of more than 102mm per minute.



MR-66022

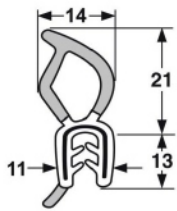

Grip Range: 1.0 - 4.0 mm

MR-66040

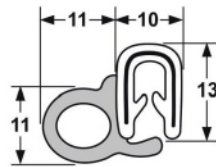

Grip Range: 1.0 - 2.5 mm

MR-66052

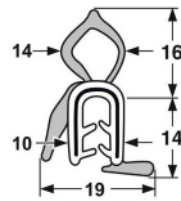

Grip Range: 1.0 - 4.0 mm

MR-66056

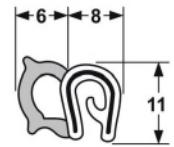

Grip Range: 1.0 - 2.5 mm

MR-66057

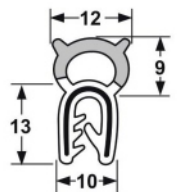

Grip Range: 1.0 - 2.5 mm

MR-66060

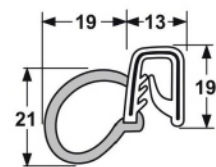

Grip Range: 2.0 - 5.0 mm

MR-66115

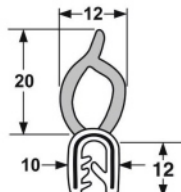

Grip Range: 1.0 - 3.0 mm

MR-66137

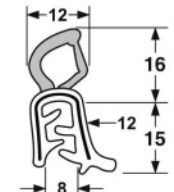

Grip Range: 1.0 - 3.0 mm

MR-66157

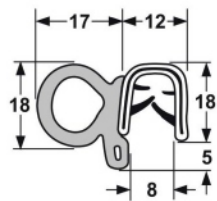

Grip Range: 1.5 - 5.0 mm



## EPDM RUBBER & SPONGE - SCHLEGEL

SCHLEGEL pinchweld type wire cage for maximum flexibility.

MR-60051SCH

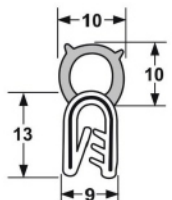

Grip Range: 1.0 - 3.0 mm

MR-60052SCH

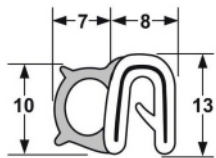

Grip Range: 1.0 - 2.0 mm

MR-60053SCH

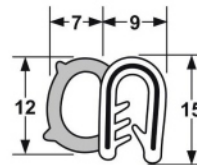

Grip Range: 1.0 - 3.0 mm

MR-60057SCH

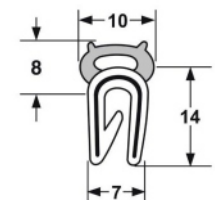

Grip Range: 1.0 - 2.0 mm

Please note that the materials have been tested to comply with the requirements of FMVSS302 (Federal Motor Vehicle Safety Standard). Submitted samples shall not burn, nor transmit a flame front across its surface at a rate of more than 102mm per minute.

# RUBBER EXTRUSION

CORD



## EPDM SPONGE CORD

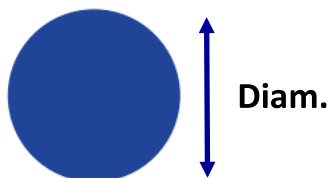

P/N	REF#	Diam
ER-ES04	P219	4mm
ER-ES05	P216	5mm
ER-ES06	P489	6mm
ER-ES07	P143	7mm
ER-ES10	P138	10mm
ER-ES12	P142	12.5mm
ER-ES15	P144	15mm
ER-ES19	P498	19mm
ER-ES25	ASC25	25mm

## EPDM CORD

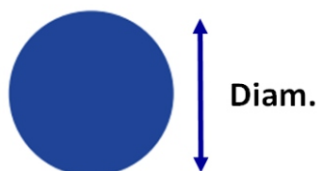

P/N	REF#	Diam
ER-EPDMCD-03		3mm
ER-EPDMCD-05		5mm
ER-EPDMCD-07		7mm
ER-EPDMCD-10		10mm
ER-EPDMCD-12		12.7mm
ER-EPDMCD-16		16mm
ER-EPDMCD-19		19mm
ER-EPDMCD-25		25mm

## NITRILE (NBR) CORD



P/N	REF#	Diam
ER-NBRCD-03		3mm
ER-NBRCD-05		5mm
ER-NBRCD-07		7mm
ER-NBRCD-10		10mm
ER-NBRCD-12		12.7mm
ER-NBRCD-16		16mm
ER-NBRCD-19		19mm
ER-NBRCD-25		25mm

## PURE GUM RUBBER CORD

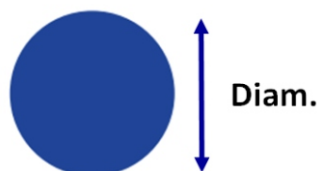

P/N	REF#	Diam
ER-PGCD-03		3mm
ER-PGCD-05		5mm
ER-PGCD-07		7mm
ER-PGCD-10		10mm
ER-PGCD-12		12.7mm
ER-PGCD-16		16mm
ER-PGCD-19		19mm
ER-PGCD-25		25mm

# RUBBER EXTRUSION EPDM SPONGE



## RECTANGULAR

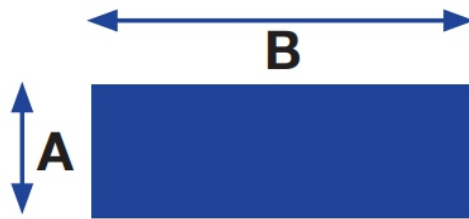

## SPONGE SECTION

P/N	REF#	A	B
ER-ES0125	P506	1.5mm	25mm
ER-ES0308	P499	3mm	8mm
ER-ES0313	P398	3mm	13mm
ER-ES0325	P399	3mm	25mm
ER-ES0332	P497	3mm	32mm
ER-ES0338	P495	3mm	38mm
ER-ES0510	P507	4.5mm	10mm
ER-ES0513	P485	5mm	13mm
ER-ES0517	P503	4.5mm	17.5mm
ER-ES0525	P496	4.5mm	25mm
ER-ES0538	P505	4.5mm	38mm
ER-ES0606	P400	6mm	6mm
ER-ES0610	60-8758	6mm	10mm
ER-ES0613	P401	6mm	13mm
ER-ES0619	P402	6mm	19mm
ER-ES0625	P403	6mm	25mm
ER-ES0632	P431	6mm	32mm
ER-ES0638	P404	6mm	38mm
ER-ES0650	P488	6mm	50mm
ER-ES0670	P433	6mm	70mm
ER-ES0810	P504	8mm	10mm
ER-ES1010	P405	10mm	10mm
ER-ES1013	P406	10mm	13mm
ER-ES1017	P501	10mm	17.5mm
ER-ES1019	60-8757	10mm	19mm
ER-ES1025	P487	10mm	25mm
ER-ES1032	P407	10mm	32mm
ER-ES1038	P545	10mm	38mm
ER-ES1050	P546	10mm	50mm
ER-ES1111	P502	11.5mm	11.5mm

P/N	REF#	A	B
ER-ES1222	P500	12.5mm	22mm
ER-ES1250	S551	12.5mm	50mm
ER-ES1313	P408	13mm	13mm
ER-ES1316	P409	13mm	16mm
ER-ES1319	P410	13mm	19mm
ER-ES1325	P411	13mm	25mm
ER-ES1338	P412	13mm	38mm
ER-ES1344	P413	13mm	44mm
ER-ES1350	P414	13mm	50mm
ER-ES1616	P415	16mm	16mm
ER-ES1619	P416	16mm	19mm
ER-ES1625	P417	16mm	25mm
ER-ES1650	P422	16mm	50mm
ER-ES1919	P423	19mm	19mm
ER-ES1925	P427	19mm	25mm
ER-ES1932	P424	19mm	32mm
ER-ES1938	P425	19mm	38mm
ER-ES1950	P426	19mm	50mm
ER-ES2222	P463	22mm	22mm
ER-ES2238	P466	22mm	38mm
ER-ES2250	P472	22mm	50mm
ER-ES2525	P428	25mm	25mm
ER-ES2532	P467	25mm	32mm
ER-ES2538	P429	25mm	38mm
ER-ES2550	P473	25mm	50mm
ER-ES3250	P476	32mm	50mm
ER-ES3838	P478	38mm	38mm
ER-ES3850	P479	38mm	50mm
ER-ES5050	P484	50mm	50mm

\* Available in 30M lengths or 10M cuts



### EPDM SOLID RUBBER STRIP

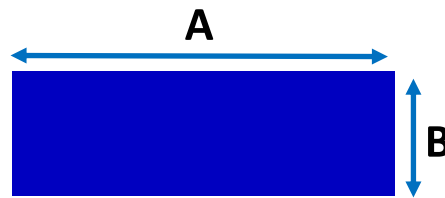

**STRIP**

P/N	A	B
ER-SRS05	5mm	5mm
ER-SRS06	6mm	6mm
ER-SRS10	10mm	10mm
ER-SRS1210	12mm	10mm
ER-SRS1303	13mm	3mm
ER-SRS1311	13mm	11mm
ER-SRS13	13mm	13mm
ER-SRS11412	14mm	12mm
ER-SRS1510	15mm	10mm
ER-SRS1512	15mm	12mm
ER-SRS1616	16mm	14mm
ER-SRS16	16mm	16mm
ER-SRS1703	17mm	13mm
ER-SRS1812	18mm	12mm
ER-SRS1913	19mm	13mm
ER-SRS19	19mm	19mm
ER-SRS2012	20mm	12mm
ER-SRS20	20mm	20mm
ER-SRS2215	22mm	15mm
ER-SRS22	22mm	22mm
ER-SRS2502	25mm	2.5mm
ER-SRS2503	25mm	3mm
ER-SRS2404	25mm	4.4mm
ER-SRS2506	25mm	6mm
ER-SRS2510	25mm	10mm
ER-SRS25	25mm	25mm
ER-SRS26	26mm	26mm
ER-SRS2706	27mm	6mm
ER-SRS2812	28mm	12mm

P/N	A	B
ER-SRS3010	30mm	10mm
ER-SRS3015	30mm	15mm
ER-SRS3204	32mm	4mm
ER-SRS3505	35mm	5mm
ER-SRS3519	35mm	19mm
ER-SRS3603	36mm	3mm
ER-SRS3606	36mm	6mm
ER-SRS3804	38mm	4.5mm
ER-SRS4002	40mm	2mm
ER-SRS4003	40mm	3mm
ER-SRS4006	40mm	6mm
ER-SRS4012	40mm	12mm
ER-SRS4020	40mm	20mm
ER-SRS4035	40mm	35mm
ER-SRS4502	45mm	2mm
ER-SRS4820	48mm	20mm
ER-SRS5001	50mm	1.2mm
ER-SRS5003	50mm	3mm
ER-SRS5005	50mm	5mm
ER-SRS5006	50mm	6mm
ER-SRS5010	50mm	10mm
ER-SRS5012	50mm	12mm
ER-SRS5025	50mm	25mm
ER-SRS5038	50mm	38mm
ER-SRS50	50mm	50mm
ER-SRS6001	60mm	1.5mm
ER-SRS6003	60mm	3mm
ER-SRS6012	60mm	12mm

P/N	A	B
ER-SRS6503	65mm	3mm
ER-SRS6505	65mm	5mm
ER-SRS6506	65mm	6mm
ER-SRS6512	65mm	12mm
ER-SRS7005	70mm	5mm
ER-SRS7030	70mm	30mm
ER-SRS7503	75mm	3mm
ER-SRS7506	75mm	6mm
ER-SRS7510	75mm	10mm
ER-SRS7513	75mm	13mm
ER-SRS8003	80mm	3mm
ER-SRS8006	80mm	6mm
ER-SRS8025	80mm	25mm
ER-SRS8503	85mm	3mm
ER-SRS10002	100mm	2mm
ER-SRS10012	100mm	12mm
ER-SRS10075	100mm	75mm
ER-SRS100	100mm	100mm
ER-SRS12010	120mm	10mm
ER-SRS12012	120mm	12mm
ER-SRS12504	125mm	4mm
ER-SRS14006	140mm	6mm
ER-SRS15012	150mm	12mm
ER-SRS15580	155mm	80mm
ER-SRS18005	180mm	5mm
ER-SRS25025	250mm	25mm

\* Minimum Order Quantities apply, please enquire.

# RUBBER EXTRUSION

SOLID



## SOLID RUBBER BLOCKS

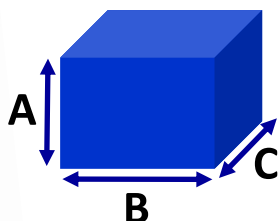

P/N	A	B	C
ER-SRB5050250	50mm	50mm	250mm
ER-SRB5050500	50mm	50mm	500mm
ER-SRB7575250	75mm	75mm	250mm
ER-SRB7575500	75mm	75mm	500mm
ER-SRB10075100	100mm	75mm	100mm
ER-SRB10075150	100mm	75mm	150mm
ER-SRB10075250	100mm	75mm	250mm
ER-SRB10075500	100mm	75mm	500mm
ER-SRB100100100	100mm	100mm	100mm
ER-SRB100100150	100mm	100mm	150mm
ER-SRB100100250	100mm	100mm	250mm
ER-SRB100100500	100mm	100mm	500mm

## SOLID FLUTED STRIPS

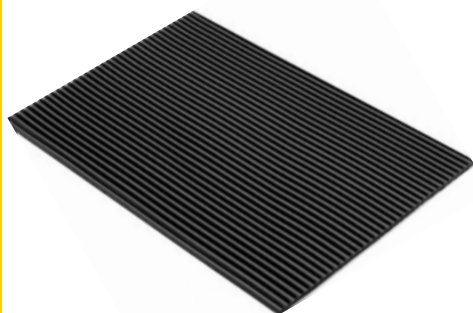

P/N	WIDTH	THICKNESS
SR-FLU25	25mm	4mm
SR-FLU30	30mm	4mm
SR-FLU45	45mm	4mm
SR-FLU65	65mm	4mm
SR-FLU75	75mm	4mm
SR-FLU100	100mm	4mm

\* Available in EPDM or SBR materials

## HATCH COVER

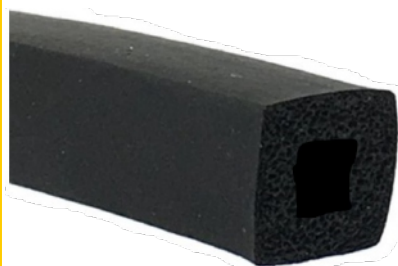

P/N	Through Hole	A	B
ER-HATCH	19mm	38mm	38mm

## SPONGE SECTION

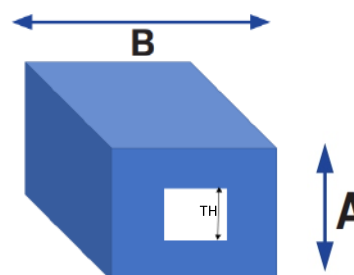

\* Some items may be made to order & MOQ may apply





## SELF ADHESIVE SPONGE - D SECTION

ER-ASD1989T

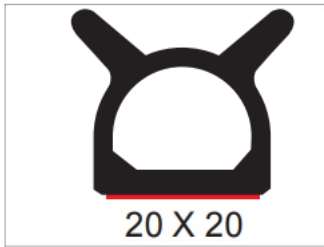

20 X 20  
33M roll

ER-AS319T

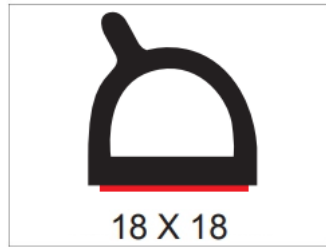

18 X 18  
33M roll

ER-AS54T



16 X 12  
33M roll

ER-AS119DT

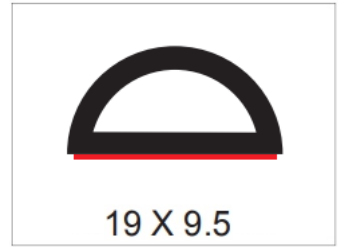

19 X 9.5  
33M roll

ER-AS125DT



19 X 12.7  
33M roll

ER-AS135DT



19 X 14.3  
33M roll

ER-AS109DT



16 X 9.5  
33M roll

ER-AS925ST



32 X 21 X 4 WALL  
30M roll

ER-DS19948T

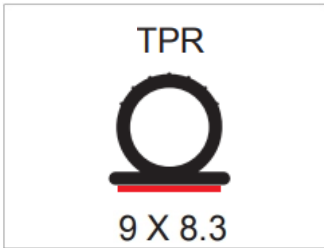

TPR  
9 X 8.3  
100M roll

AS31STER-ASD2422T

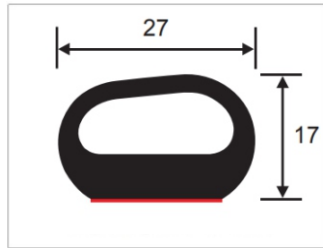

ER-ASP95T(W/GY)

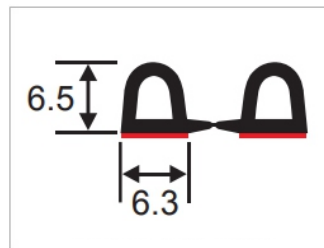

Available in White (W) or Grey (GY)

ER-ASD96T(W/GY)

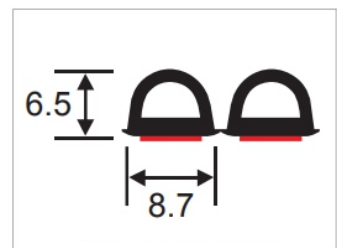

## SELF ADHESIVE SPONGE - SPECIAL

ER-ASE104T

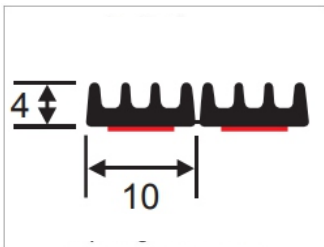

ER-ASE158T

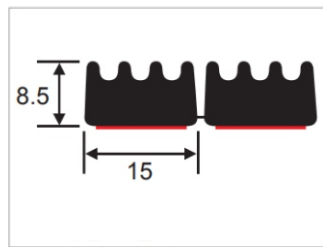

ER-AS31ST



20 X 16  
30M roll

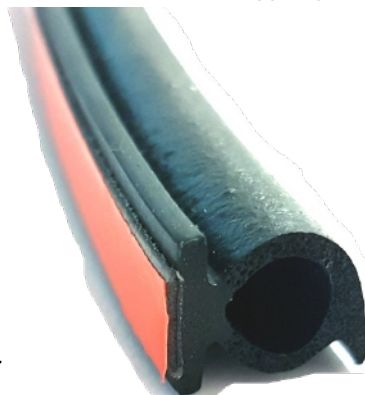
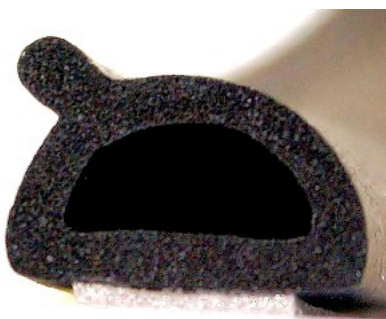

\* Some items may be Made to order & MOQ may apply.

# RUBBER EXTRUSION EPDM SPONGE



ER-31-044R



ER-39-089R



ER-39-092R



ER-39-144R

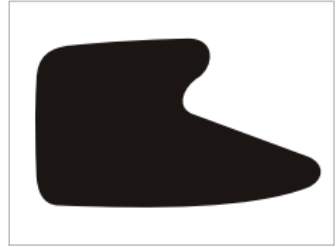

ER-39-159R



ER-39-236R

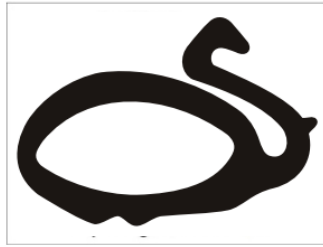

ER-39-316R



ER-39-399R



ER-39-416R



ER-39-478R

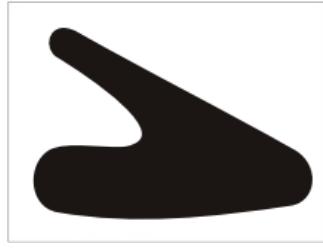

ER-39-480R

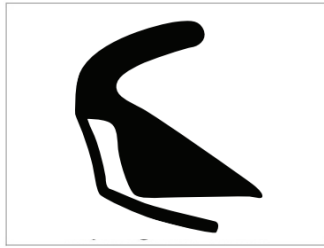

ER-39-497R

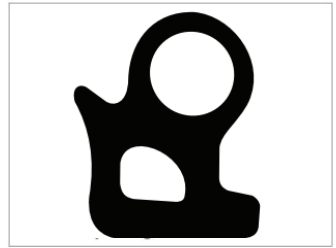

ER-39-499R

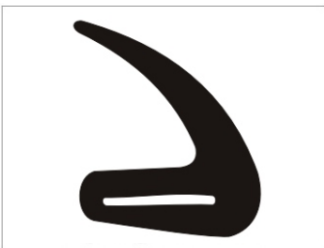

ER-39-592

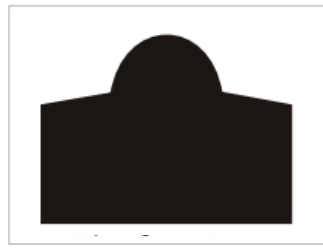

ER-39-593



ER-39-594

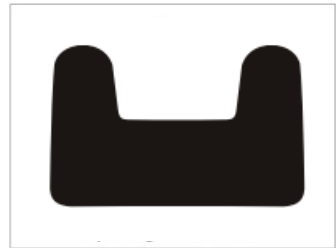

ER-39-607



ER-39-8979

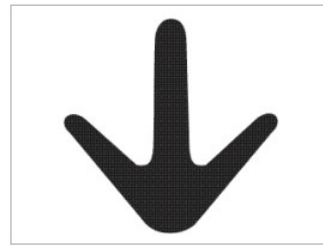

ER-39-618

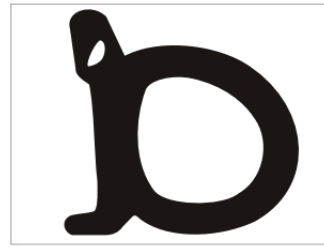

ER-39-620

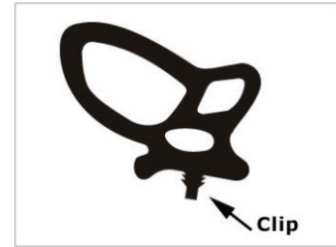

Some items may be Made to order & MOQ may apply.

# RUBBER EXTRUSION EPDM SPONGE



ER-39-668



ER-39-8799



ER-39-8840

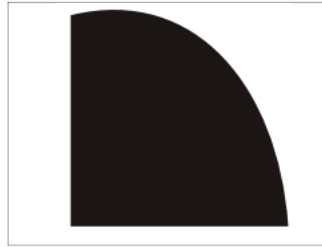

ER-39-8841



ER-60-A01

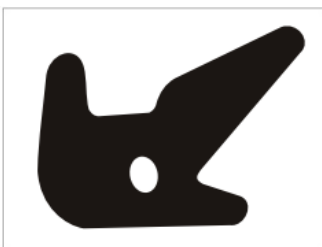

ER-60-A02



ER-60-A12

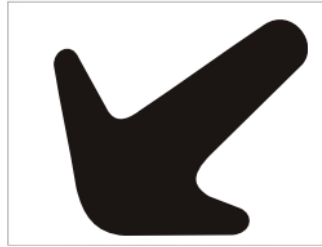

ER-60-B01

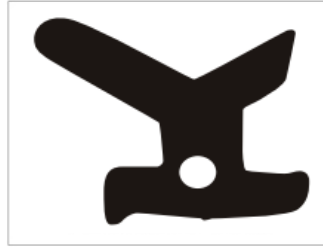

ER-60-B03



ER-60-B05

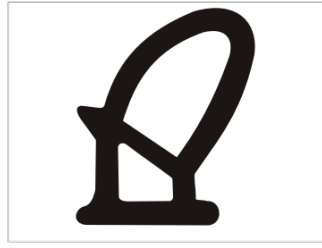

ER-60-B06

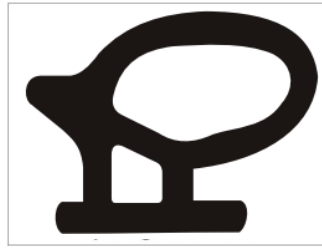

ER-60-B13

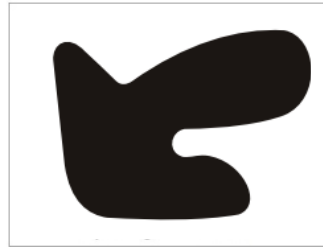

ER-60-D06



ER-FJ121- (S184)

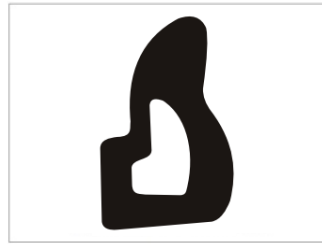

ER-#G124 (S315)



ER-RSC97

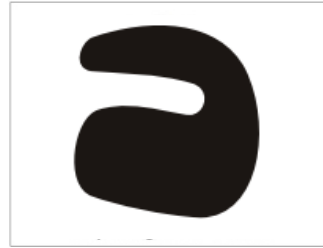

ER-S125

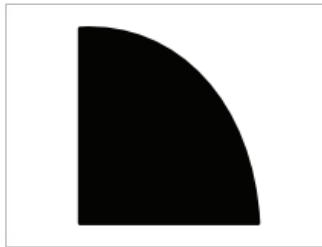

ER-S126



ER-S147



ER-S185

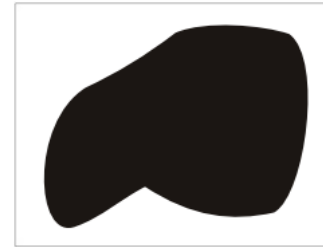

Some items may be Made to order & MOQ may apply.



### E-SEALS

ER-DS5RE

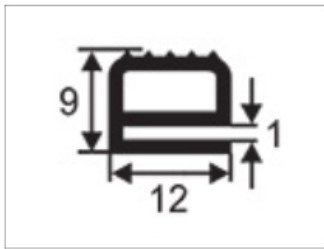

ER-DS10RE

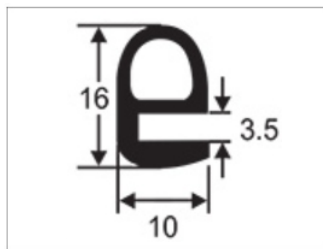

ER-DS11RE

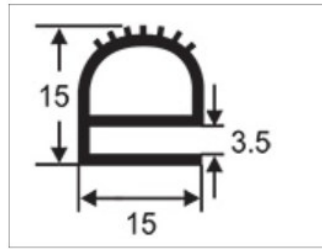

ER-DS12RE

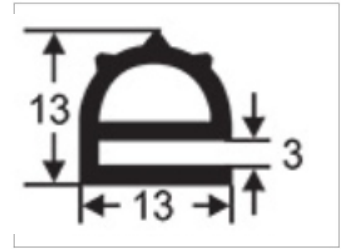

ER-DS13RE

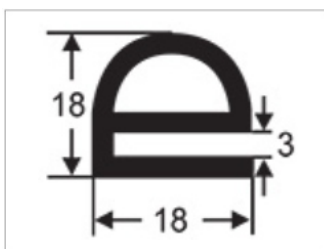

ER-DS15RE

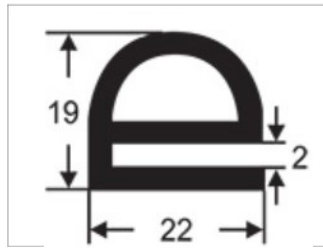

ER-DS20RE

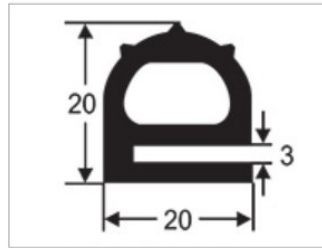

ER-DS25RE

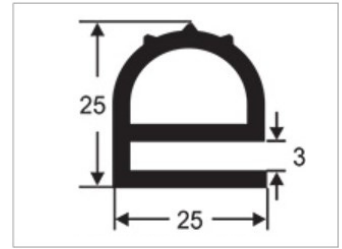

### MISC-SEALS

ER-DS35RE

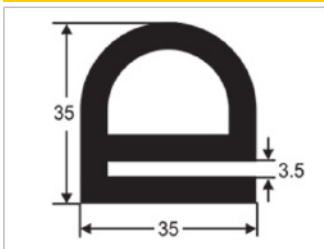

ER-DS45RE

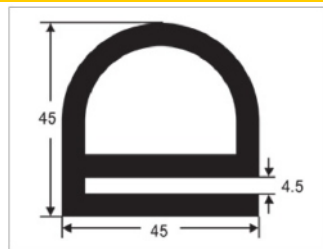

ER-DS857

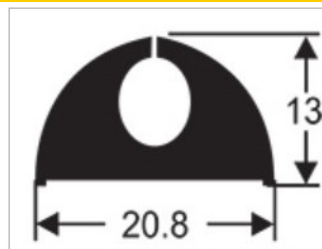

ER-DSCOMPACT



### H-SEALS

ER-DS15H

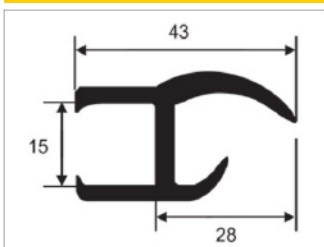

ER-DS20H

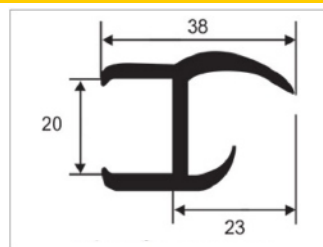

ER-DS25H

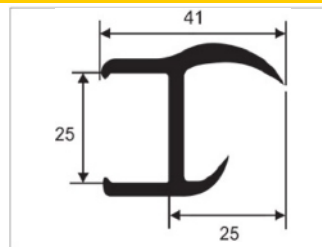

ER-DS32H

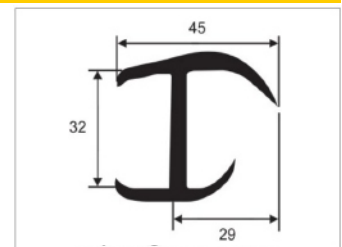

### J-SEALS

ER-DS15J

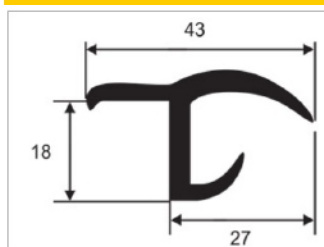

ER-DS20J

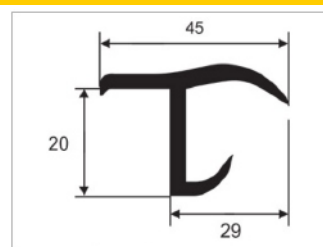

ER-DS25J

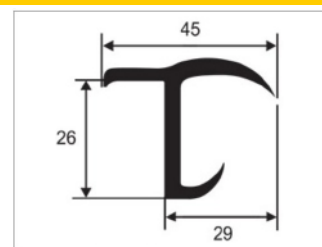

ER-DS32J

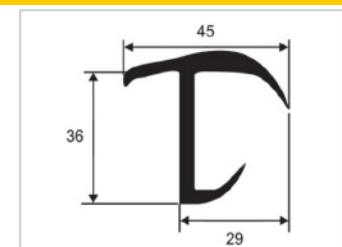

Some items may be Made to order & MOQ may apply.



### P-SEALS

ER-DSP067

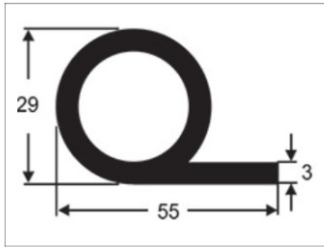

ER-DSP095

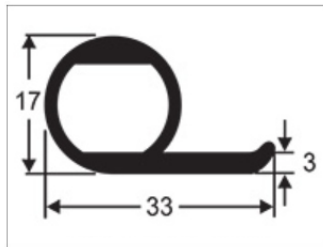

ER-DSP100

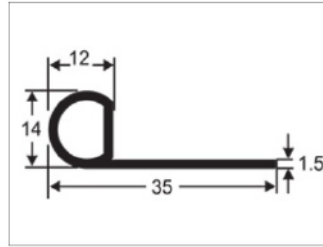

ER-DSP104

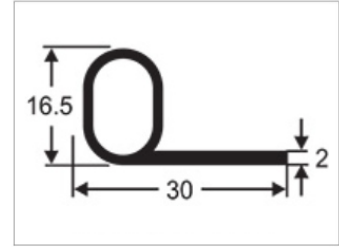

ER-DSP105

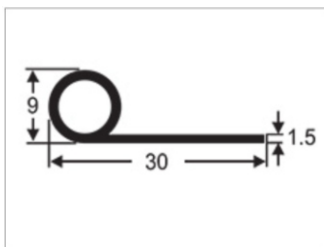

ER-DSP107

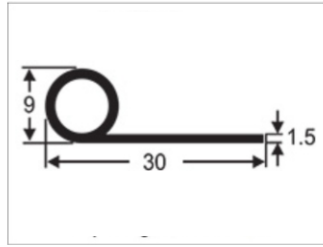

ER-DSP109

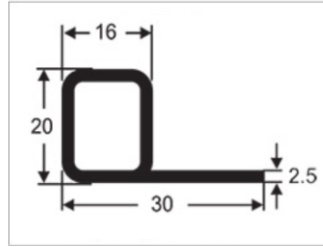

ER-DSP111

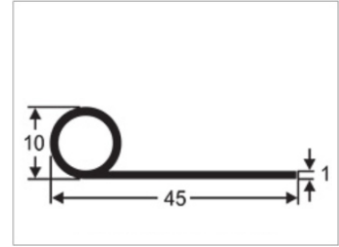

ER-DSP165

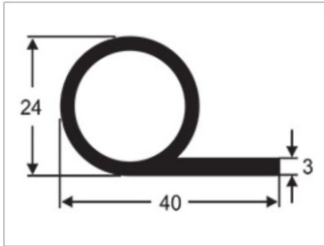

ER-DSP409

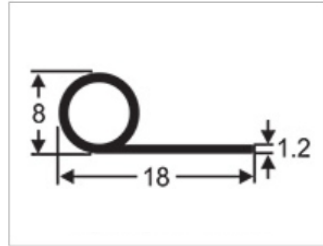

ER-DSP920

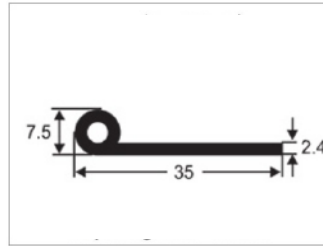

ER-DS124

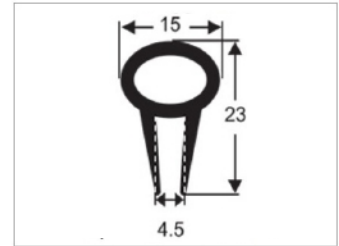

### IRRIGATION SEALS

ER-IRR1077

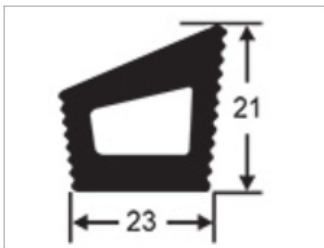

ER-IRR1244

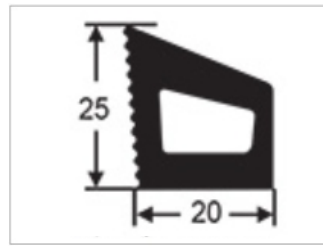

ER-IRR285

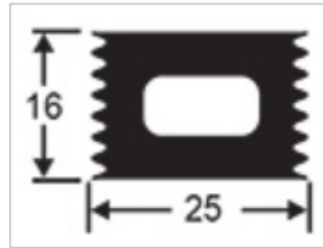

ER-IRR620

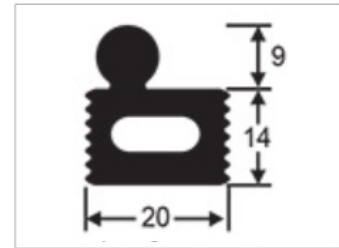

ER-DIRR631

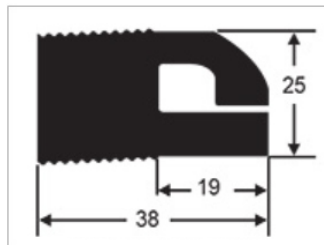

ER-IRR700

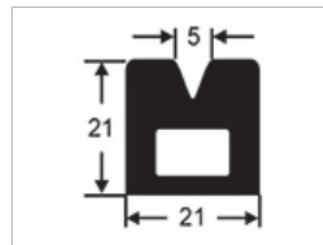

ER-IRR266

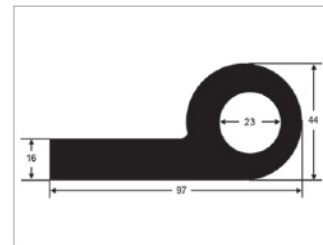

ER-IRR279

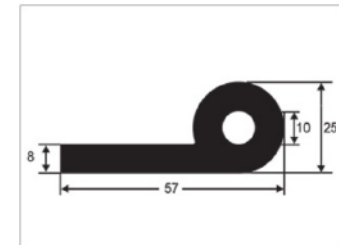

Some items may be Made to order & MOQ may apply.

# RUBBER EXTRUSION

SOLID



ER-1032

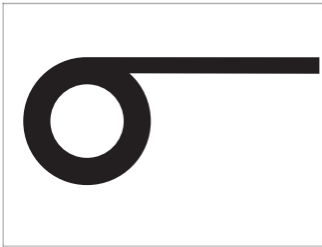

ER-1130

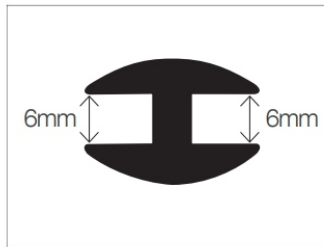

ER-39-178R



ER-39-335R

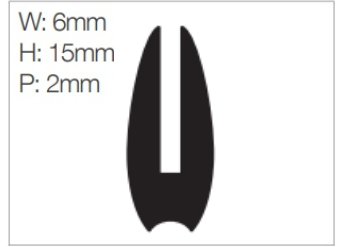

ER-39-358R

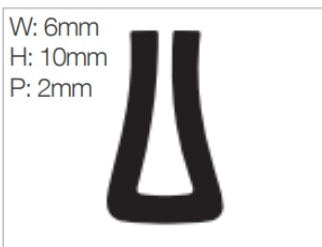

ER-39-520R

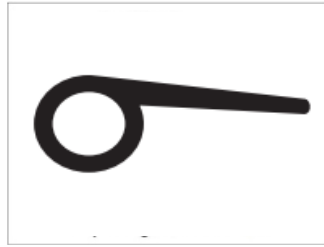

ER-39-527R

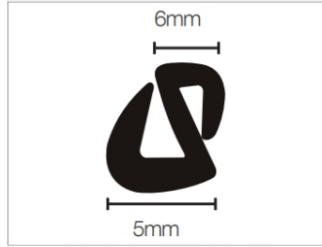

ER-39-544R

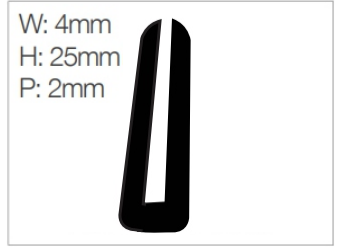

ER-39-557R



ER-39-558R



ER-39-559R

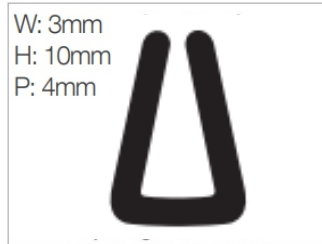

ER-39-560R

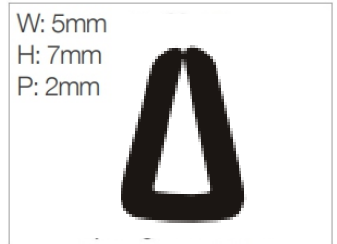

ER-39-561R

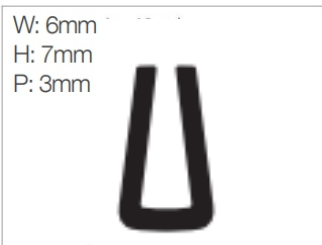

ER-39-562R

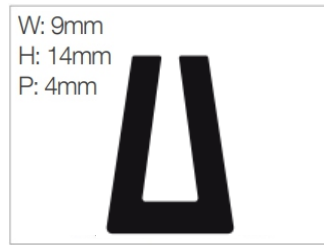

ER-39-589



ER-39-590



ER-39-591



ER-39-669

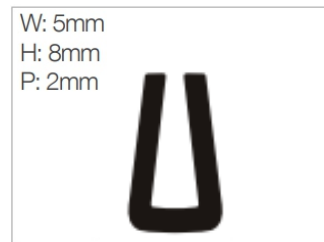

ER-39-670

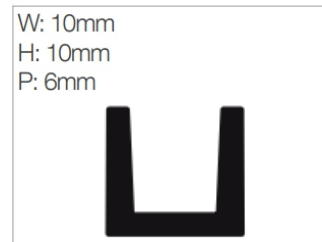

ER-39-671

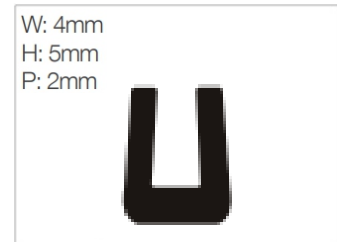

Some items may be Made to order & MOQ may apply.

# RUBBER EXTRUSION

SOLID



<p><b>ER-39-8801</b></p> <p>W: 4mm H: 20mm P: 1mm</p>	<p><b>ER-39-8803</b></p> <p>W: 5mm H: 8mm P: 2mm</p>	<p><b>ER-39-8804</b></p> <p>W: 8mm H: 12mm P: 2mm</p>	<p><b>ER-39-8805</b></p> <p>W: 8mm H: 9mm P: 5mm</p>
<p><b>ER-39-8806</b></p> <p>W: 5mm H: 15mm P: 3mm</p>	<p><b>ER-39-8807</b></p> <p>W: 3mm H: 12mm P: 1mm</p>	<p><b>ER-39-8824</b></p> <p>W: 8mm H: 12mm P: 3mm</p>	<p><b>ER-39-8838</b></p> <p>W: 6mm H: 14mm P: 3mm</p>
<p><b>ER-43-029AR</b></p> <p>4mm 5mm</p>	<p><b>ER-512</b></p>	<p><b>ER-51-638</b></p>	<p><b>ER-520</b></p>
<p><b>ER-530</b></p>	<p><b>ER-539</b></p>	<p><b>ER-542</b></p>	<p><b>ER-550</b></p>
<p><b>ER-559</b></p>	<p><b>ER-566</b></p> <p>W: 6mm H: 11mm P: 4mm</p>	<p><b>ER-568</b></p> <p>W: 13mm H: 12mm P: 7mm</p>	<p><b>ER-575</b></p> <p>1mm 5mm</p>

Some items may be Made to order & MOQ may apply.

# RUBBER EXTRUSION

SOLID



## PROFILES

ER-647	ER-648	ER-649	ER-676
			<p>W: 8mm H: 14mm P: 5mm</p>
ER-704	ER-778	ER-781	ER-904

## E-SEALS

ER-921	ER-934	ER-ESEAL19	ER-ESEAL35
<p>W: 9mm H: 15mm P: 6mm</p>	<p>W: 7mm H: 12mm P: 5mm</p>		

## P-SEALS

ER-PSEAL10	ER-PSEAL12	ER-PSEAL18	ER-PSEAL29

## H-SEALS

## D-SEALS

## WHEEL ARCH

ER-HSEAL25	ER-DSEAL16	ER-DSEAL18	ER-51-444	ER-51-462
<p>Supplied in 15 Meter coils</p>	<p>Self Adhesive Tape</p>	<p>Self Adhesive Tape</p>	<p>Side fitting wheel arch flare</p>	<p>Under fitting wheel arch flare</p>

Some items may be Made to order & MOQ may apply.



# RUBBER EXTRUSION



## COVER STRIP

ER-CS500

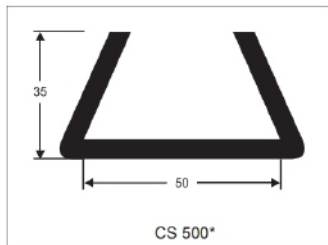

ER-CS450

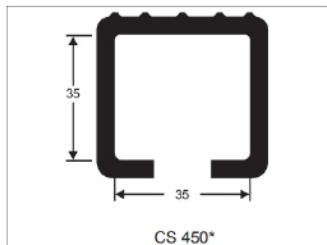

ER-CS478

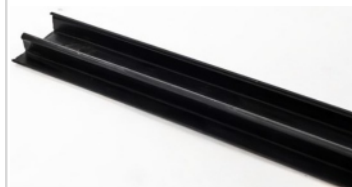
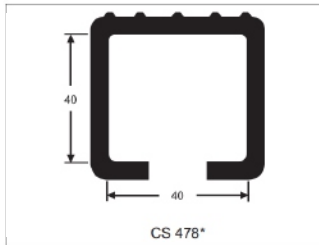

## REFRIGERATION GASKET

ER-RFFG11

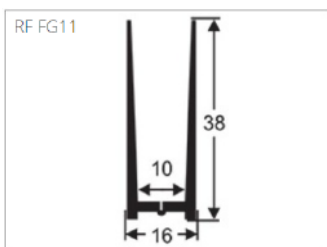

ER-RFD14

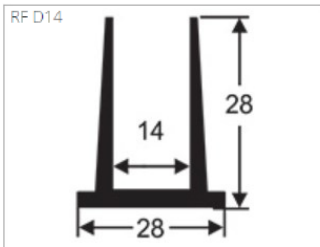

ER-RFD11MK3

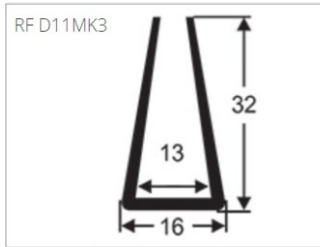

## FENDER PIPING / FLARE

ER-PLAF17365

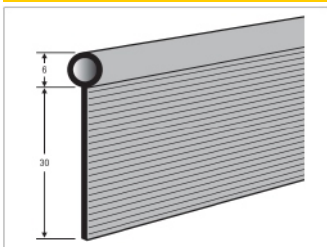

ER-PLA77976

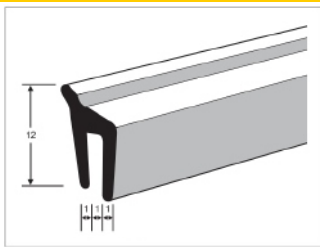

## L SECTION

ER-L70709

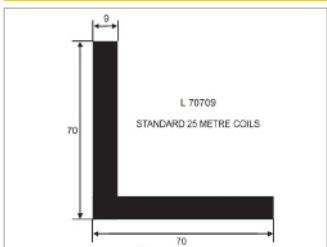

ER-L50504

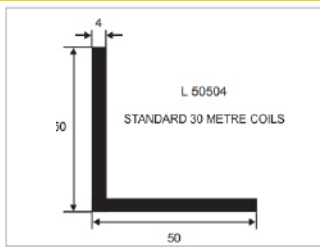

ER-L811

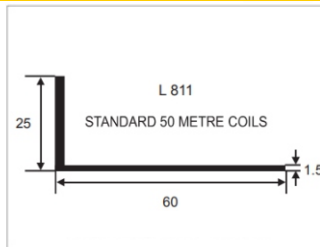

ER-L40203

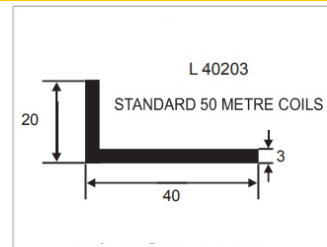

ER-L30304

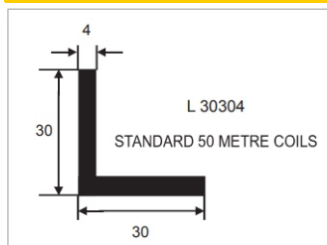

ER-L1443

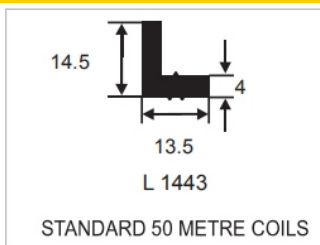

ER-DIE1192

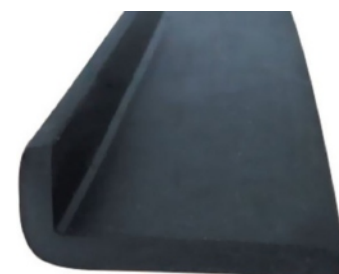
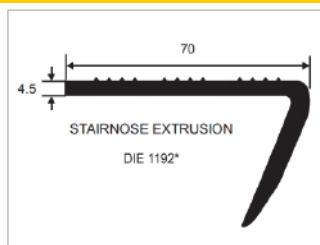

\* Some items may be Made to order & MOQ may apply.



### BAILEY CHANNEL - FLOCKED RUBBER

ER-31-025



ER-32-006

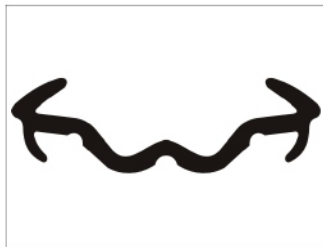

ER-39-037R



ER-39-068R



ER-39-069R



ER-39-401

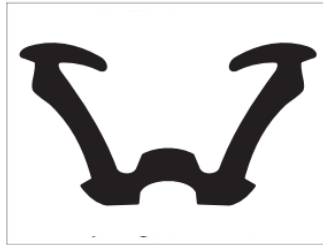

ER-39-424



ER-39-426



ER-39-500



ER-39-501

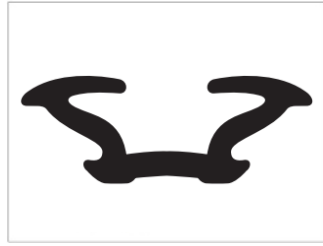

ER-39-502



ER-39-622



ER-39-628

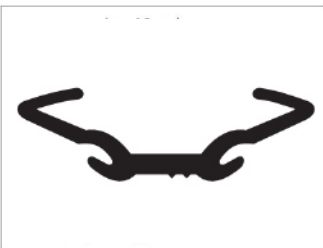

ER-39-8785

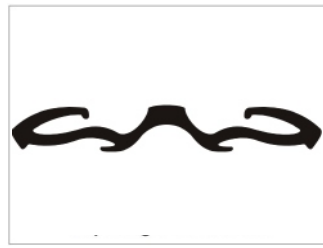

ER-39-8848



ER-39-51-903



ER-64-017

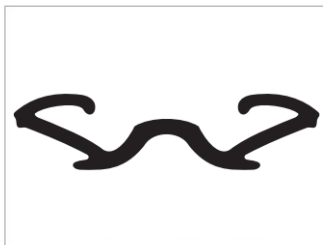

ER-64-020

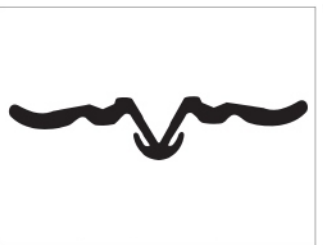

ER-64-026



ER-64-067



*Some items may be Made to order & MOQ may apply.*



### BAILEY CHANNEL - FLOCKED RUBBER

ER-64-139



ER-64-143



ER-64-153



ER-64-193 (4018701)



ER-SS1150 - 30M



### WINDSCREEN INSERTION STRIP

ER-K120

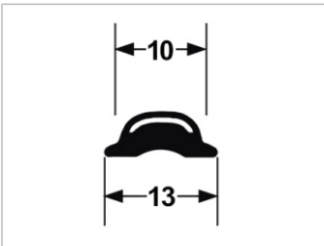

ER-K120

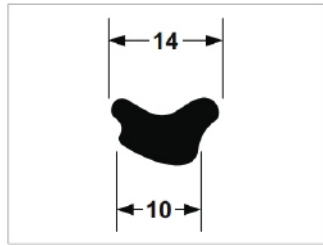

ER-K150 (MYLAR)

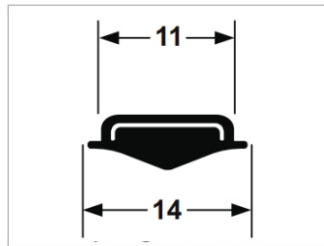

ER-K150BL( RUBBER)

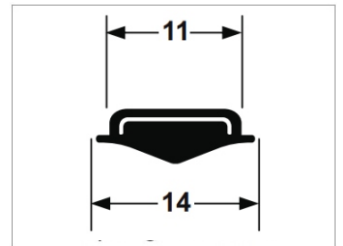

ER-K160

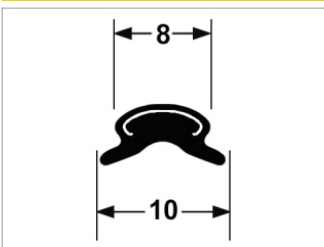

ER-410

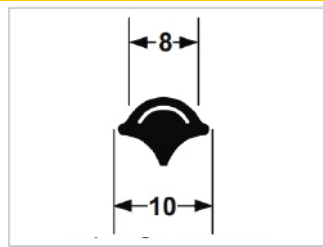

ER-K540

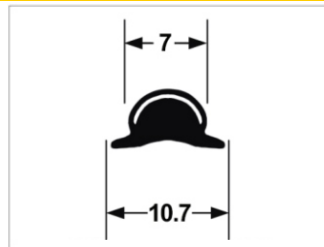

ER-K960

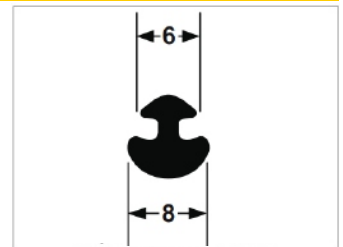

Some items may be Made to order & MOQ may apply.



### CHANNELS & LOCKING STRIPS

ER-GR1059/779

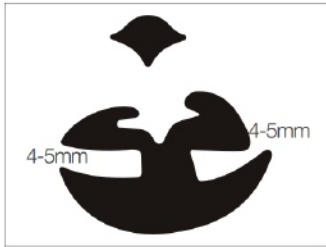

ER-GR1204/929

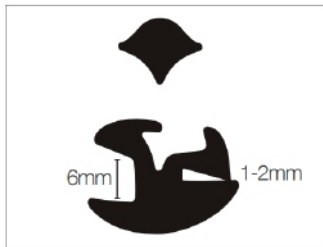

ER-GR39-8517R



ER-GR39-8846

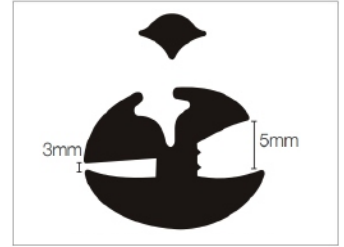

ER-GR51-004/992

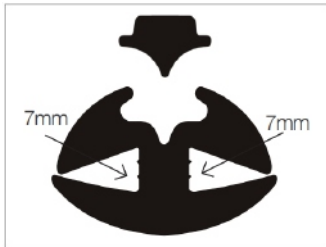

ER-GR778/779

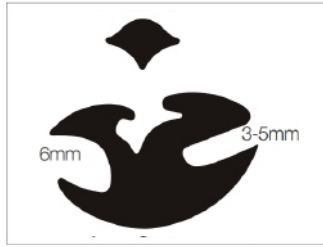

ER-GR779



ER-GR928

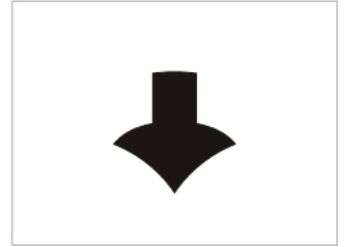

ER-GR928/929

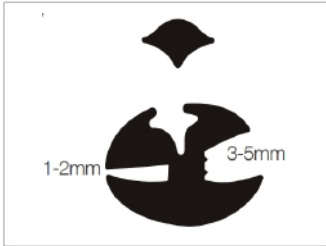

ER-GR929



ER-GRFJ002

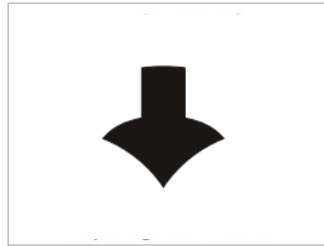

ER-GRFX001

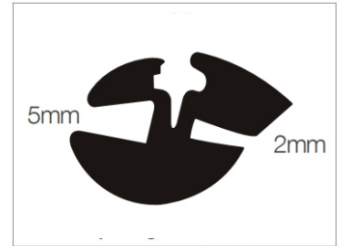

ER-GRFX002

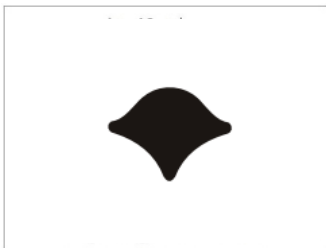

Some items may be Made to order & MOQ may apply.



### GLAZING RUBBER

ER-GR025

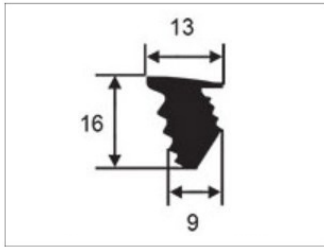

ER-GR081

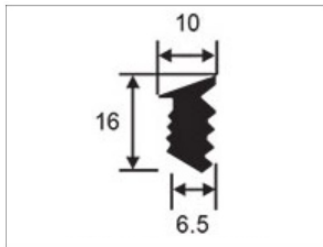

ER-GR10

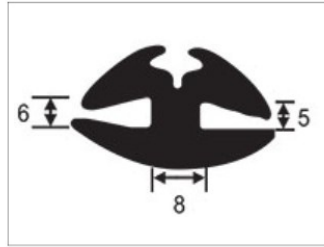

ER-GR1058

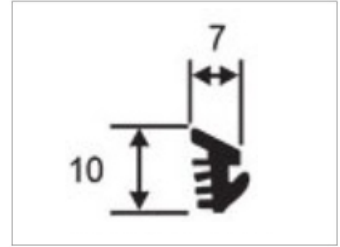

ER-GR1059

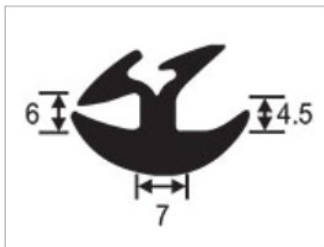

ER-GR1059SL

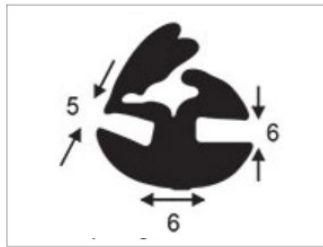

ER-GR1084

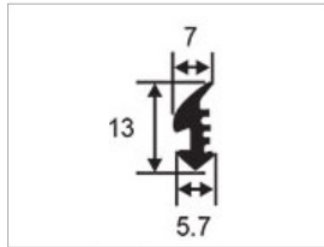

ER-GR1085

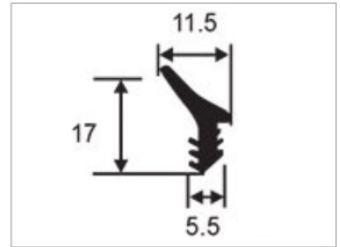

ER-GR1128

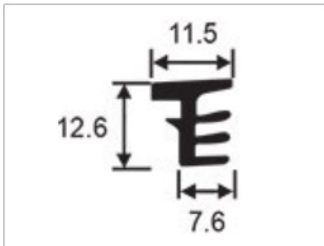

ER-GR1145

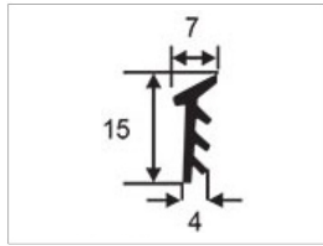

ER-GR1253

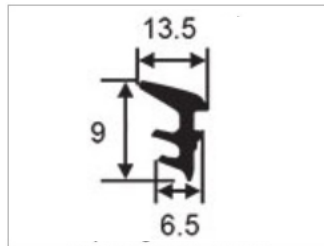

ER-GR1294

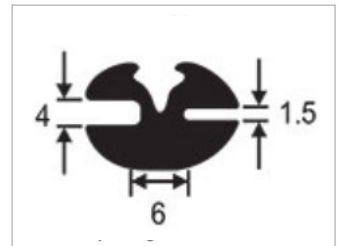

ER-GR1300

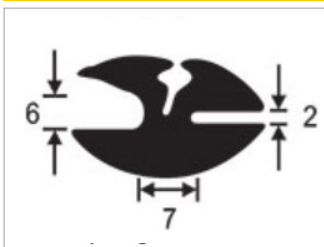

ER-GR1389

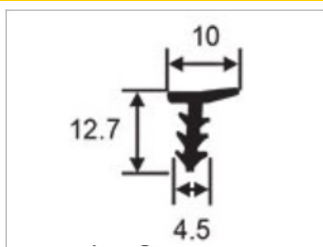

ER-GR1506



ER-GR1507



ER-GR1509



ER-GR1511



ER-GR1512



ER-GR1514



Some items may be Made to order & MOQ may apply.



### GLAZING RUBBER

ER-GR1517	ER-GR1518	ER-GR1520	ER-GR1522
ER-GR1523	ER-GR2	ER-GR207	ER-GR209
ER-GR247	ER-GR265SL	ER-GR3	ER-GR309
ER-GR372	ER-GR378	ER-GR4	ER-GR402
ER-GR416	ER-GR5	ER-GR503	ER-GR6

Some items may be Made to order & MOQ may apply.



### GLAZING RUBBER

ER-GR703

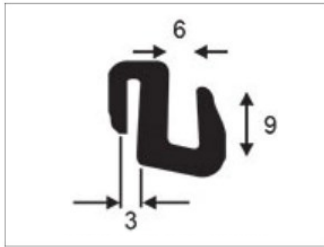

ER-GR704

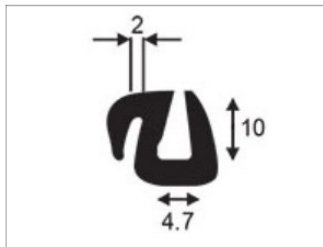

ER-GR748

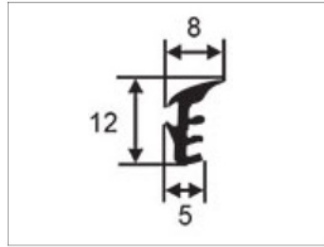

ER-GR764

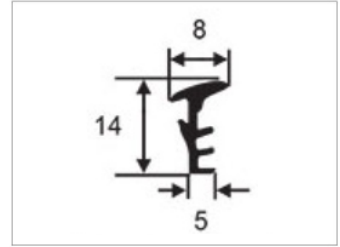

ER-GR778

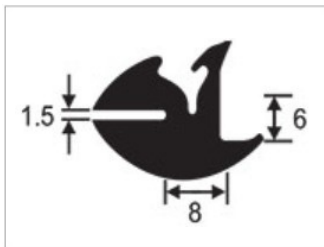

ER-GR778SL

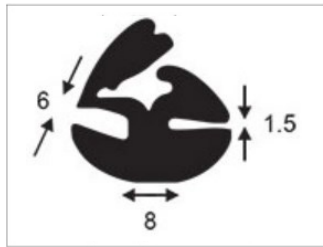

ER-GR8

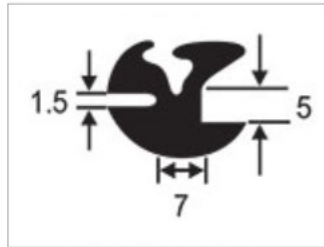

ER-GR8SL

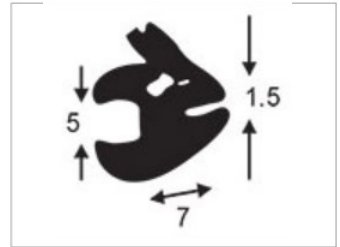

ER-GR904

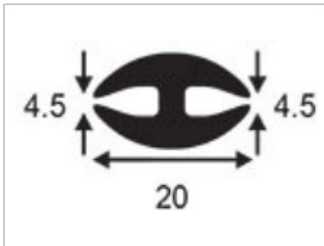

ER-GR504

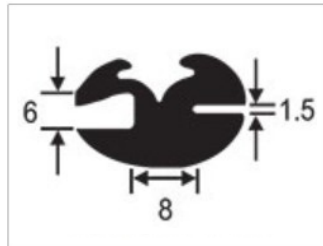

ER-GR542

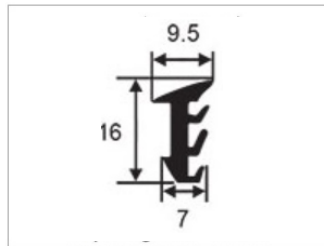

ER-GR562

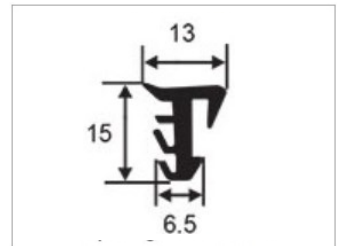

ER-GRL1

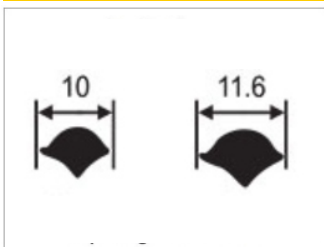

Some items may be Made to order & MOQ may apply.

# RUBBER EXTRUSION

## CAPPING



ER-U01

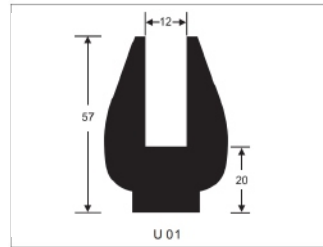

ER-U02

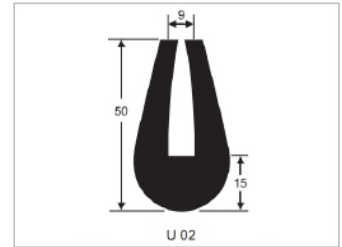

ER-U03

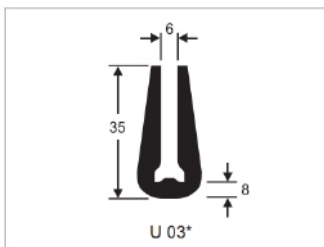

ER-U04

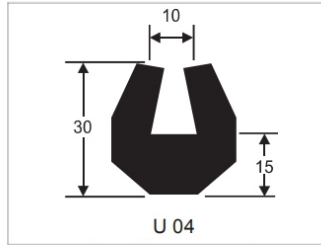

ER-U05

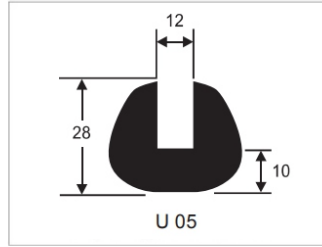

ER-U06

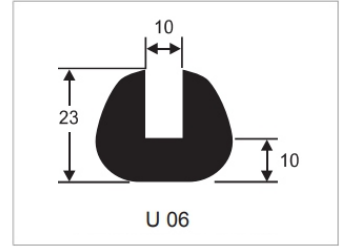

ER-U07

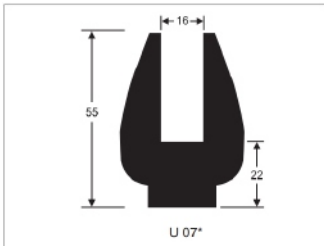

ER-U08

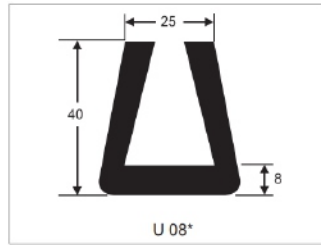

ER-U09

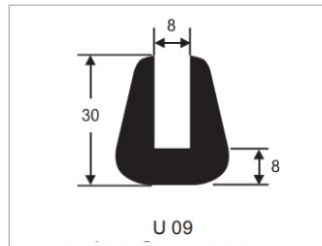

ER-U010

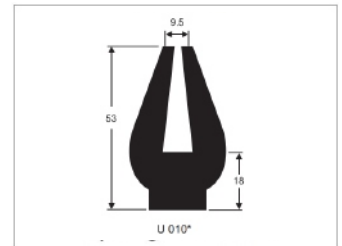

ER-U012

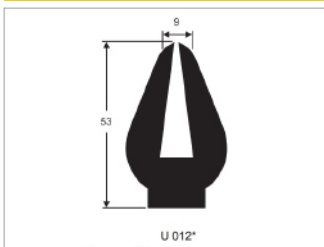

ER-U493

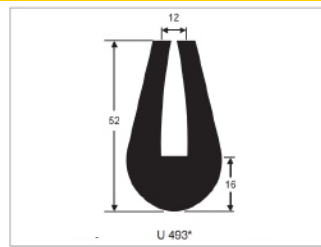

ER-UGRIP13

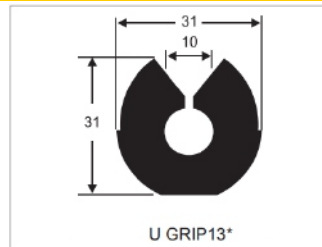

ER-U1098

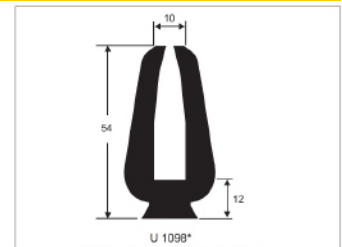

ER-U1093

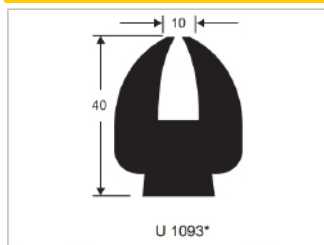

Some items may be Made to order & MOQ may apply.





### VARIOUS SPECIALTY RUBBER ALSO AVAILABLE



**ALLOY ADHESIVE BACKING**

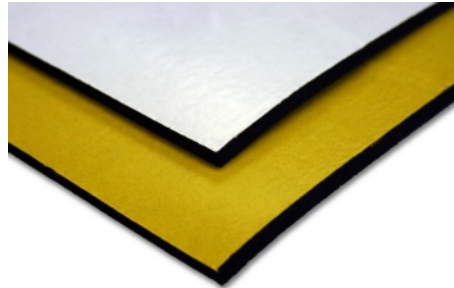

**RUBBER SHEET ADHESIVE BACKING**



**ABRASIVE RESISTANT COATED BELTS**



**SPEED HUMPS**

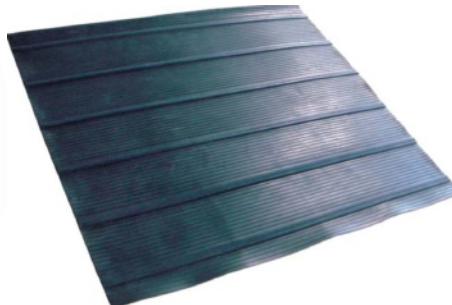

**TAILGATE RAMP MATTING**



**RUBBER STOPPERS**



**ENDURANCE RUBBER MATTING**



**GROMMETS**



**ENGINEERED RUBBER**

*Some items may be Made to order & MOQ may apply.*



# SPECIALTY RUBBER PRODUCTS

For Assistance please contact Michael: 0488 917 285 or  
[michael@irrigationdirect.com.au](mailto:michael@irrigationdirect.com.au)

